

Nordic Imbalance Settlement Handbook

Instructions and Rules for Market Participants
2 September 2024

Business process: Nordic Imbalance Settlement
Version: 4.8
Status: For contractual basis

Terminology

Terminology		
Term	Abbreviation	Explanation
Balance Responsible Party	BRP	A company that has a valid Imbalance Settlement Agreement with eSett and a valid Balance Agreement with a TSO and manages a Balance Obligation on its own behalf as a producer, consumer, or trader of electricity or on the behalf of other producers, consumers, or traders of electricity.
Balancing Service Provider	BSP	A company that has a valid Settlement Agreement with eSett and a valid BSP Agreement or another agreement with Transmission System Operator (TSO) or otherwise bound by terms and conditions set forth by TSO. A balancing service provider means a market participant with reserve-providing units (e.g. production units) or reserve-providing groups (regulation units) able to provide balancing services to TSOs.
Balance Obligation		An obligation of the Balance Responsible Party to continuously plan for and achieve balance between the electricity supplied and withdrawn by one or several producers, consumers, or traders of electricity and to perform the financial settlement of any Imbalances arising from the electricity supplied and withdrawn by these parties. Balance Obligation requirements are defined and governed by the TSO responsible for the Market Balance Area where the Balance Responsible Party operates.
Balancing Energy		An energy used by TSOs to perform balancing and provided by a balancing service provider. An activated volume of reserves.
Balancing Market		The entirety of institutional, commercial, and operational arrangements that establish market-based management of the function of Balancing within the framework of the European Network Codes.
Balancing Services		A balancing energy or balancing capacity or both.
Closed Distribution Networks		A market participant without a grid license can form a metering grid area (e.g. industrial or power production site) by applying for a closed network license from the regulator. Please see the term DSO.
Delivery Day		A day of delivery during which the Market Participants delivers the power in-feed or withdrawals to the system. The reporting follows the delivery days.
Distribution System Operator	DSO	An owner of a distribution grid that has the responsibility to distribute electricity from producers to customers. The DSOs have the responsibility to meter production, consumption and exchange and report the metered data to the involved stakeholders. This term also refers to the operators of closed distribution networks.
Frequency Containment Reserves	FCR	Frequency Containment Reserves mean the Operational Reserves activated to contain System Frequency after the occurrence of an imbalance.
Frequency Restoration Reserves	FRR	Frequency Restoration Reserves mean the Active Power Reserves activated to restore System Frequency to the Nominal Frequency and for Synchronous Area consisting of more than one LFC Area power balance to the scheduled value.

Terminology		
Term	Abbreviation	Explanation
Imbalance		An energy volume calculated for a Balance Responsible Party and representing the difference between the allocated volume (physical energy volumes) and the final position (traded energy volumes), including any imbalance adjustment applied, within a given imbalance settlement period.
Imbalance Adjustment		An energy volume representing the Balancing Energy from a Balancing Service Provider and applied by the Connecting TSO for an Imbalance Settlement Period to the concerned Balance Responsible Parties, for the calculation of the Imbalance of these Balance Responsible Parties.
Imbalance Settlement Period	ISP	Imbalance settlement period means the time unit for which balance responsible parties' imbalance is calculated. A 15-minute imbalance settlement period is applied. ¹
Imbalance Settlement Responsible	ISR	A party that is responsible for settlement of the difference between the contracted quantities and the realised quantities of energy products for the Balance Responsible Parties in a Market Balance Area.
Incentivizing Component	IC	The incentivizing component is an additional component which can be included in the imbalance price calculation to fulfil nationally defined boundary conditions. In the Nordics, the boundary conditions imply that the imbalance price should equal the day-ahead price in ISPs without dominating direction. To ensure this, the IC is applied together with VoAA in ISPs without dominating direction.
Key Performance Indicator	KPI	KPIs are utilised to measure the performance of different market participants. KPIs are a transparent way to display how TSOs, DSOs, BRPs and REs carry out their respective responsibilities.
Market Balance Area	MBA	An area within the power system that works as an imbalance area in which an imbalance is calculated. In NBS model a MBA is equal to a bidding zone and scheduling area, and imbalance price area is equal to one or more MBAs. An imbalance price is always the same within a MBA.
Market Entity	ME	A collective term for MBA, MGA, PU and RO.
Market Entity Connection	MEC	Market Entity Connection is a collective term for different kinds of connections either between different MPs (e.g. bilateral trades between parties) or MPs and MEs (e.g. MP's metered consumption in MGA or MP's production plan per RO). The MEC's time series data is the core of imbalance settlement.
Nominated Electricity Market Operator	NEMO	The unique power exchange of trades (PX market trades) for the actual delivery of energy that receives the bids from the Market Participants that have a contract to bid. The Market Operator(s) determine(s) the market energy price for the Market Balance Area after applying technical constraints from the System Operator. It may also establish the price for reconciliation within a Metering Grid Area.
Market Participants	MP	Market Participants are the main stakeholders in the settlement: the TSOs, DSOs, NEMOs, BRPs, BSPs and REs. These enter into transactions in one or more wholesale energy markets.
Metered data		Metered (metering) data is, in this Handbook, used as a general term for all the data that the market participants meter, collect and report to eSett for imbalance settlement purpose.

¹ In Nordics, introduction of 15-minute imbalance prices and market time unit (MTU) for cross-border trading is planned for Q1 in 2025.

Terminology		
Term	Abbreviation	Explanation
Metered Data Aggregator		A party responsible for the establishment and qualification of metered data from the Distribution System Operator. This data is aggregated according to a defined set of market rules. This role or function can be represented locally by a national electricity market hub or DSO.
Metering Grid Area	MGA	A Metering Grid Area is a physical area where consumption and / or production and exchange can be metered. An MGA can include both production and consumption but also only one of these. It is delimited by the placement of meters for period measurement for input to, and withdrawal from the area. It can be used to establish the sum of consumption and production with no period measurement and network losses. MGAs are decided on the national level. One company can be responsible for more than a one metering grid area and one company is responsible for all metering points within one MGA.
Power Exchange	PX	A power exchange (PX market) is a sales forum or marketplace used by energy producers and consumers on a wholesale level.
Production Unit	PU	A Production Unit is a generator or a set of generators within the same power plant in one MGA. A Production Unit is equal to a power generating facility.
Retailer	RE	A Retailer sells electricity to an end user. It sells and buys electricity directly from a producer, another retailer or via a Nominated Electricity Market Operator. An RE has an agreement with a BRP. In Finland, an RE may have an agreement with a BRP, or with another RE who has an agreement with a BRP (chain of open supplier).
Regulation Object	RO	A Regulation Object (RO) is a set of one or more generators and stations within an MBA, with the exception of Norway and Denmark where RO may span more than one MBA. One RO can only include production of a certain technology (wind, hydro, nuclear, etc.). There can only be one BRP per RO.
Replacement Reserves	RR	Replacement Reserves mean the reserves used to restore/support the required level of FRR to be prepared for additional system imbalances. This category includes operating reserves with activation time from Time to Restore Frequency up to hours.
Service Provider	SP	A Service Provider is a party that provides operational balance management and settlement services for the market participants e.g. BRPs, REs and DSOs. The SP performs the corresponding tasks towards eSett and the imbalance settlement system, according to what services the SP provides to the market participant.
Transmission System Operator	TSO	A Transmission System Operator has the responsibility for the security of supply, for the real-time coordination of supply and demand in the power system, and for the operation of the high-voltage grid. The TSO also bear the ultimate responsibility for imbalance settlement according to the national laws. In this document "TSO" refers primarily, and "Nordic TSO" refers solely, to the Transmission System Operators in Denmark (Energinet), Finland (Fingrid Oyj), Norway (Statnett SF) and Sweden (Svenska kraftnät).
Value of Avoided Activation	VoAA	Value of avoided activation is a reference price that can be calculated by the TSO or TSOs of a given MBA after the balancing energy gate closure time for a given ISP, at least when there is no balancing energy demand for that MBA for that ISP or no balancing energy activation for that MBA for that ISP.

Detailed contents of the chapters

Detailed contents of the chapters	
Chapter	Contents
1. Introduction	<ul style="list-style-type: none"> • Basic information about the Nordic Imbalance Settlement project • Purpose of the NBS Handbook • Information sources to national regulations • Introduction to eSett
2. Nordic imbalance settlement model	<ul style="list-style-type: none"> • High-level description of the model and functions • Roles and responsibilities of each market participant • Contents of the agreements between eSett and market participants
3. Settlement structure management	<ul style="list-style-type: none"> • Description of the settlement structure • Responsibilities and time schedules for reporting settlement structure information • Examples of changes to the settlement structure
4. Metering	<ul style="list-style-type: none"> • Metering of settlement data
5. Settlement data reporting	<ul style="list-style-type: none"> • Reporting requirements • Responsibilities and schedules for reporting settlement data • Instructions on how the reporting for production and consumption is done
6. Imbalance settlement	<ul style="list-style-type: none"> • Principles of imbalance settlement • Calculation of imbalance volume • An example of imbalance calculation • National reconciliation procedures
7. Pricing and fees	<ul style="list-style-type: none"> • Pricing of imbalances • Fees charged to BRPs in imbalance settlement • An example of the: Calculation of imbalance amounts
8. Invoicing	<ul style="list-style-type: none"> • Contents of invoices to BRPs and BSPs for imbalances, reserves and fees • Procedure and schedule for invoices and payments • Required banking setup • Consideration of value-added taxes • Currency treatment
9. Collateral and risk management	<ul style="list-style-type: none"> • Counterparty risk management model • Calculation of collateral requirements • Collateral procedures • Requirements on settlement banks
10. Communication	<ul style="list-style-type: none"> • Applied data communication standard • Services provided by eSett; messaging service, information service and online service • Reports provided by eSett
11. Market behaviour reporting	<ul style="list-style-type: none"> • Monitoring of market behaviour including published reports • Key performance indicators • Sanctions and controls from bad market behaviour
12. Change log	<ul style="list-style-type: none"> • Summary of changes made to different versions of the NBS Handbook
13. Appendices	<ul style="list-style-type: none"> • Requirements on a Balance Responsible Party • Nordic Calendar • Swedish Profiling and Reconciliation

Table of Contents

TERMINOLOGY	1
DETAILED CONTENTS OF THE CHAPTERS	4
TABLE OF CONTENTS	5
1 INTRODUCTION	7
1.1 BACKGROUND.....	7
1.2 SCOPE	8
1.3 BENEFITS	8
1.4 REGULATION	9
1.5 NORDIC IMBALANCE SETTLEMENT RESPONSIBLE eSETT	10
2 NORDIC IMBALANCE SETTLEMENT MODEL	13
2.1 THE IMBALANCE SETTLEMENT MODEL	13
2.2 ROLES, RESPONSIBILITIES AND REQUIREMENTS	14
2.3 CALENDAR AND TIME ZONES.....	19
2.4 IMBALANCE RESPONSIBILITY AND AGREEMENTS	19
2.5 COMPANY DATA MODEL	22
3 SETTLEMENT STRUCTURE MANAGEMENT	24
3.1 SETTLEMENT STRUCTURE	24
3.2 MARKET PARTICIPANTS	25
3.3 MARKET ENTITIES.....	26
3.4 MARKET ENTITY CONNECTIONS	27
3.5 REPORTING RESPONSIBILITIES AND SCHEDULES	28
4 METERING.....	35
4.1 METERED DATA BY TYPES.....	36
4.2 REPLACE OR ESTIMATE MISSING VALUES	36
4.3 MGA EXCHANGE METERS AND MGA EXCHANGES	37
4.4 PRODUCTION METERING	37
4.5 CONSUMPTION METERING	39
4.6 ENERGY STORAGES	39
5 SETTLEMENT DATA REPORTING	42
5.1 REPORTING REQUIREMENTS.....	42
5.2 REPORTING DATA FLOWS.....	43
5.3 REPORTING SCHEDULES	46
5.4 REPORTING RESPONSIBILITY	47
5.5 VALIDATION OF REPORTED DATA	59
5.6 REPORTING IN DISTURBANCE SITUATIONS	59
6 IMBALANCE SETTLEMENT	60
6.1 IMBALANCE SETTLEMENT CALCULATION.....	60
6.2 EXAMPLE: CALCULATION OF IMBALANCE VOLUMES	61
6.3 IMBALANCE SETTLEMENT WITH MISSING DATA	62
6.4 MANAGEMENT OF IMBALANCE ERRORS AFTER GATE CLOSURE.....	62
6.5 IMBALANCE SETTLEMENT IN DISTURBANCE SITUATIONS	63
6.6 RECONCILIATION.....	63
7 PRICING AND FEES.....	65
7.1 PRICING OF IMBALANCE	65
7.2 FEES IN THE IMBALANCE SETTLEMENT	66

7.3	EXAMPLE: CALCULATION OF IMBALANCE AMOUNTS.....	68
8	INVOICING.....	69
8.1	INVOICE CONTENTS.....	69
8.2	INVOICE DISTRIBUTION	71
8.3	DEBITING AND CREDITING OF INVOICE AMOUNTS	72
8.4	REQUIRED BANKING SETUP	72
8.5	INVOICING SCHEDULE.....	74
8.6	HANDLING OF EXCEPTIONS.....	75
8.7	VALUE-ADDED TAXES	76
8.8	CURRENCY TREATMENT	77
9	COLLATERAL AND RISK MANAGEMENT.....	79
9.1	COUNTERPARTY RISK	79
9.2	PROVISION OF COLLATERAL.....	80
9.3	CALCULATION OF COLLATERAL REQUIREMENT	80
9.4	COLLATERAL OF BRPs OPERATING IN MULTIPLE COUNTRIES.....	82
9.5	CURRENCY TREATMENT	83
9.6	COLLATERAL MANAGEMENT PROCEDURES	83
9.7	BRPs WITH INSUFFICIENT DEPOSITED COLLATERAL	83
9.8	RELEASE OF COLLATERAL	83
9.9	MONITORING OF SETTLEMENT BANKS.....	84
9.10	COLLATERAL MANAGEMENT RELATED TO THE RECONCILIATION INVOICES	84
9.11	COLLATERAL MANAGEMENT OF BSPs.....	85
10	COMMUNICATION	86
10.1	MESSAGING SERVICE.....	86
10.2	DATA PACKAGES	87
10.3	INFORMATION SERVICE.....	90
10.4	DATA COMMUNICATION STANDARDS.....	91
10.5	OPEN DATA.....	93
10.6	ONLINE SERVICE.....	93
10.7	EXAMPLE OF INFORMATION ACCESS RIGHTS IN THE NBS MODEL	96
10.8	ESETT'S REPORTING.....	97
11	MARKET BEHAVIOUR REPORTING	99
11.1	MONITORING	99
11.2	KEY PERFORMANCE INDICATORS	99
11.3	SANCTIONS AND CONTROLS	104
12	CHANGE LOG	105
13	APPENDICES	114
APPENDIX 1	REQUIREMENTS ON BECOMING A BALANCE RESPONSIBLE PARTY	115
APPENDIX 2	NORDIC CALENDAR	117
APPENDIX 3	SWEDISH PROFILING AND RECONCILIATION	118

1 Introduction

This chapter provides basic information about the Nordic Imbalance Settlement Model. Additionally, the purpose and contents of the Nordic Imbalance Settlement (NBS) Handbook along with information sources for national regulations are presented.

There must always be a balance between supply and consumption of electricity. To achieve this, the Transmission system operators (TSOs) use balancing power procured from the balancing power market. Imbalances arise from uncertainties in plans and from failures in generation, consumption, and the grid. Imbalance settlement is therefore a necessary function in a commercial electricity market. Historically, Fingrid, Svenska kraftnät, Statnett and Energinet each have been operating their own imbalance settlement and been responsible for supervising the balance of the electricity systems in Finland, Sweden, Norway, and Denmark, respectively.

Today eSett Oy (Imbalance Settlement Responsible, ISR) organisation is responsible for performing imbalance settlement and invoicing BRPs for imbalances and BSPs for balancing

services. eSett Oy (eSett) is owned by the four TSOs; Energinet, Fingrid, Statnett and Svenska kraftnät with an equal share.

Each TSO is still responsible for national settlement in accordance with the national regulations and for verifying that the Imbalance Settlement Model and eSett fulfil such regulations.

The model provides harmonised operational preconditions for all Nordic balance responsible parties, regardless of the country or market balance area. Nordic-level business processes for reporting, performing settlement, invoicing and collateral management are established. Consequently, similar rules and standards for information exchange are created.

This Nordic Imbalance Settlement Handbook compiles all the Instructions and Rules into one easily accessible source. It is the main source of information needed for each market participant to understand their role and responsibility in the settlement process. A market participant can have several roles in the Imbalance Settlement Model (e.g. a TSO can have roles as a BRP, BSP, RE and DSO).

One of the most important goals of the Handbook is to provide information about the Imbalance Settlement Model in a structured and understandable way so that all market participants can work equally in the electricity market in all Nordic countries. Inevitably, some national differences will remain, and it may not be possible to harmonise these in the short term. Therefore, the national regulations are an important source of information, in addition to this Handbook. This Handbook also includes references to the information sources to national regulations.

1.1 Background

New versions of the Handbook will be published on a regular basis. The market participants will be informed about the updated Handbook on the web site and by newsletter that the market participants can subscribe to on www.esett.com.

A Customer Committee is established to provide a dialogue between eSett and stakeholders. The Customer Committee consists of market representatives and a TSO representative from each NBS Country. In addition, the energy market authorities responsible for regulation approval and execution from all NBS countries can participate in the meetings. All the major changes to the NBS model will be discussed in the Customer Committee before they are implemented. Therefore, the Customer Committee has an important role in the development of the NBS model. The changes and updates to the NBS model will be recorded in the NBS Handbook.

The normal update cycle of Handbook will be twice a year, once in the spring and once in the autumn. However, eSett reserves the right to carry out small updates and clarifications to the NBS Handbook when these changes have an urgent nature, and they are clearly seen to be beneficial to the market and/or when the update adds clarity to the processes described in the Handbook. All change will be summarised in the change log available at the end of this document (see Chapter 12).

In addition to the Handbook the following sources include information which is to be taken into account by the market participants are:

- Common rules in the electricity law and secondary legislations in Denmark, Finland, Norway and Sweden as referred to in Chapter 1.4 Regulation.
- User Guide for XML documents for NBS; a detailed user guide for the ENTSO-E and ebIX® XML documents used in the Nordic Balancing System, available at <https://ediel.org/>
- BRS (Business Requirement Specification for Data Exchange in Nordic Balance Settlement); a technical specification for the ENTSO-E and ebIX® XML documents used in the Nordic Balancing System, available at <https://ediel.org/>
- NBS XML schemas and examples on <https://ediel.org/>
- NBS related acknowledgements are according to NEG UserGuide Acknowledgements at <https://ediel.org>
- Communication guidelines for the Imbalance Settlement System at <https://www.esett.com/customers/data-communications/>
- BRP Agreements at <https://www.esett.com/customers/agreements/>
- BSP Agreements at <https://www.esett.com/agreements-fees-bsp/>

1.2 Scope

The main function of the Nordic Imbalance Settlement Model is the common imbalance settlement. eSett performs imbalance settlement and manages invoicing and collaterals towards the Balance Responsible Parties (BRP) and Balancing Service Providers (BSP) on behalf of the Transmission System Operator (TSO) in each country. All matters directly related to system operations, for example procurement of balancing services, are outside the scope of the Imbalance Settlement Model. The Imbalance Settlement Model will take all necessary volumes into account when calculating the imbalance and furthermore, eSett is responsible for invoicing of the balancing services as part of imbalance settlement.

1.3 Benefits

The model includes several benefits for the electricity market. The Nordic Imbalance Settlement is the platform for common imbalance settlement in Denmark, Finland, Norway, and Sweden. This means that a BRP always has a single interface (eSett) and one set of rules when settling its imbalances in the Nordic electricity market. The main reason for establishing a common imbalance settlement solution is the creation of a competitive end user market. Increased competition and reduced margins for the electricity providers will give rise to socioeconomic efficiency gain.

Competition through a common Nordic retail market is considered essential in order to ensure high quality services at the lowest price, to stimulate innovation and to maximise social welfare in the Nordic region.

In general, the Nordic Imbalance Settlement Model will lower the threshold of acting as a BRP since the model enables common access to all four countries. In addition, the operational procedures of a BRP are simplified. It makes it easier for a retailer to enter the market. It also reduces costs as more BRPs are competing and the price for handling an RE's balance could therefore be lower. Besides, a RE can more easily choose to act as a BRP rather than an RE.

The Nordic Imbalance Settlement Model gives an incentive to improve the quality of meter data as the DSOs must notify and be responsible for data errors after the imbalance settlement period is closed. Improved data quality will not only improve the quality of imbalance settlement but, also the settlement and invoicing of end customers as both BRPs and REs get access to the same meter data.

A larger market with a common set of rules will make it more attractive to invest in innovation. BRPs, BSPs and REs will face a larger potential for innovative solutions, especially for the core IT systems and new payment and credit management solutions. This will also make the vendor market more attractive as the offers from various service providers will cover a larger market.

A common Nordic approach to imbalance settlement procedures will have more influence on EU development than if there were several different Nordic solutions. NBS will, in the long run, lower the operational costs of imbalance settlement because one organisation with one common IT solution will be more efficient than several separate ones. NBS will also make the related costs more transparent as these will be separated from cost elements at each respective TSO. Such transparency is a condition for operational cost efficiency.

1.4 Regulation

The national legislation and regulations per each respective country are presented in this chapter.

The Nordic Imbalance Settlement model follows the settlement principles as per Title V of Commission Regulation (EU) 2017/2195 of 23 November 2017 establishing a guideline on electricity balancing. <https://eur-lex.europa.eu/legal-content/EN/TXT/?uri=CELEX%3A32017R2195>

1.4.1 Finland

In Finland, the following laws and secondary regulations guide the electricity market:

- Electricity market act (EMA) (588/2013) (Finnish version) Common rules in the electricity law and secondary legislations in the Nordic countries provide additional <https://finlex.fi/fi/laki/ajantasa/2013/20130588>
- Decrees of the Finnish government and decrees of the ministry of the employment and the economy:
 - The Finnish Government decree of electricity deliveries settlement and measurement (66/2009) (dated 2009-02-05) <https://finlex.fi/fi/laki/ajantasa/2009/20090066>
 - The Ministry of the Employment and the Economy decree of the information exchange concerning electricity deliveries settlement (273/2016) (dated 2016-04-13) <https://finlex.fi/fi/laki/alkup/2016/20160273>

National terms and conditions for BRP concerning balance management and imbalance settlement: <https://www.fingrid.fi/en/electricity-market/balance-service/>

National terms and conditions for BSP concerning reserves and balancing power (separate for each balancing service): https://www.fingrid.fi/en/electricity-market/reserves_and_balancing/

1.4.2 Norway

In Norway the following laws and secondary regulations guide the electricity market:

- Primary act: LOV 1990-06-29 nr 50: Lov om produksjon, omforming, overføring, omsetning, fordeling og bruk av energi m.m. (energiloven) - "The Energy Act" <https://lovdata.no/dokument/NL/lov/1990-06-29-50>
- Secondary Legislation: FOR 1999-03-11 nr 301: Forskrift om måling, avregning og samordnet opptreden ved kraftomsetning og fakturering av netjtjenester - "MAF" <https://lovdata.no/dokument/SF/forskrift/1999-03-11-301>

1.4.3 Sweden

In Sweden the following laws and secondary regulations guide the electricity market:

- Energy market act: SFS 1997:857 "Ellag" http://www.riksdagen.se/sv/dokument-lagar/dokument/svenskforfattningssamling/ellag-1997857_sfs-1997-857
- Power regulation: "Förordning om mätning, beräkning och rapportering av överförd el" www.regeringen.se
- Secondary legislation: EIFS 2023:1 <https://ei.se/download/18.575c50c318602a42957643/1675150192171/EIFS-om-m%C3%A4tning-ber%C3%A4kning-och-rapportering-av-%C3%B6verf%C3%B6rd-el-EIFS-2023-1.pdf>

National balance responsibility agreements for BRP and BSP: <https://www.svk.se/en/stakeholders-portal/electricity-market/balance-responsibility/balance-responsibility-agreement/>

1.4.4 Denmark

In Denmark the following laws and secondary regulations guide the electricity market:

- The electricity Supply Act (Lov om elforsyning, LBK nr 119 af 06/02/2020): <https://www.retsinformation.dk/Forms/R0710.aspx?id=212784>
- Executive order on the system operator and use of the electricity transmission network (Systemansvarsbekendtgørelsen, BEK nr 1402 af 13/12/2019) <https://www.retsinformation.dk/Forms/R0710.aspx?id=211785>
- Secondary legislation in the Danish electricity market regulations (approved by the Danish Utility Regulator): <https://energinet.dk/EI/Elmarkedet/Regler-for-elmarkedet/Markedsforskrifter>

1.5 Nordic Imbalance Settlement Responsible eSett

eSett is owned by Energinet, Fingrid, Svenska kraftnät and Statnett. The company will act and operate in the role of Imbalance Settlement Responsible. It must be noted that the national regulations stipulate that each national TSO is still ultimately responsible for balancing operations and imbalance settlement.

The company's working language is English, but customer service is also provided in Swedish, Norwegian and Finnish. eSett's relations to the market participants are illustrated in **Figure 1**.

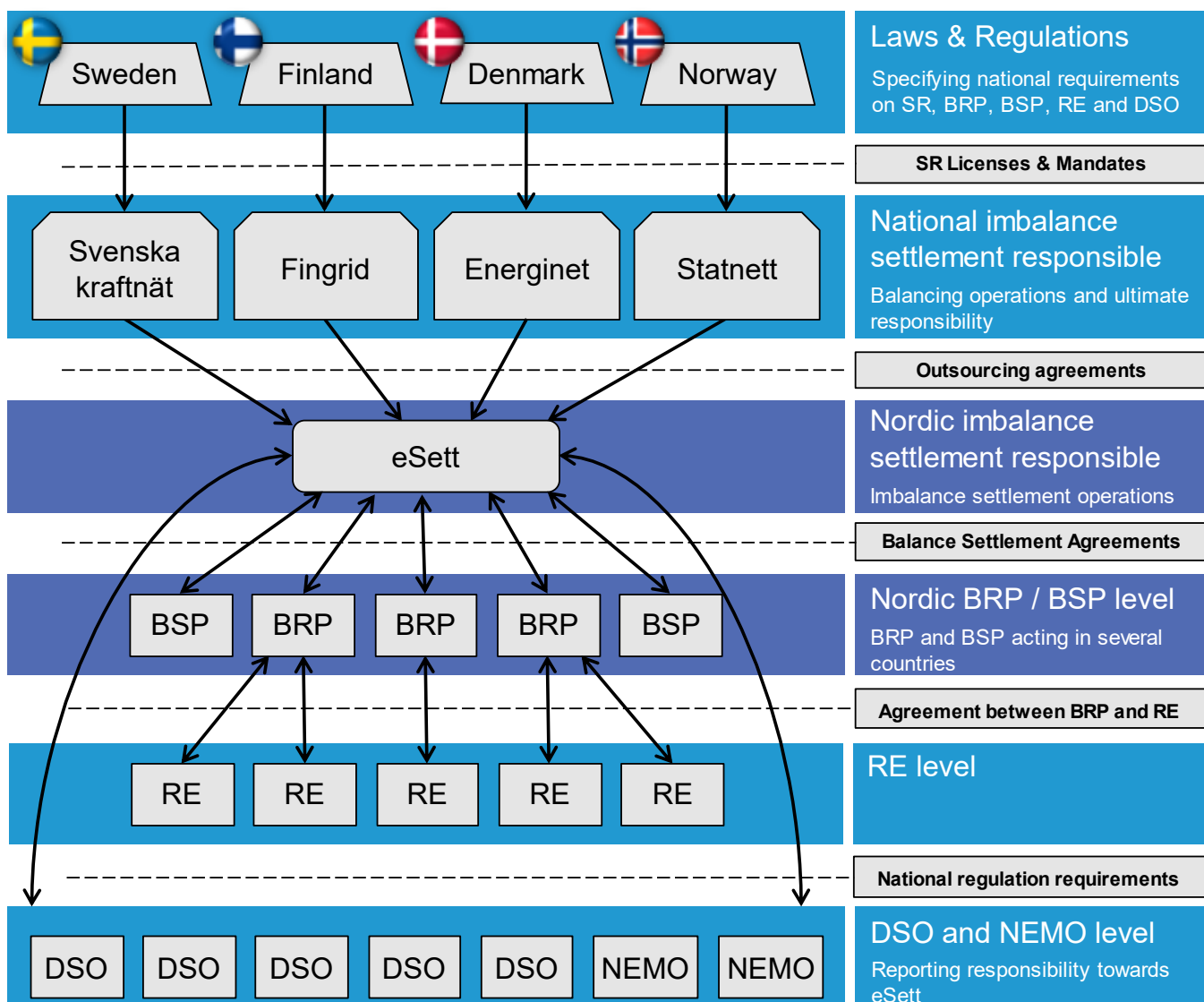

Figure 1. Relations between eSett and the market participants.

1.5.1 eSett's Operations

eSett has many operational tasks. Its daily processes include collecting, validating and managing data related to imbalance settlement, making the collected data available for market participants, conducting preliminary imbalance settlement, following up reported data and performing final imbalance settlement. Weekly duties for eSett consist of performing the imbalance settlement related invoicing, invoicing of other fees on behalf of TSOs, controlling BRPs' and BSPs' collaterals and follow-up them in relation to risk and collaterals, and cash management. On a regular basis eSett will monitor, publish and follow-up Key Performance Indicator (KPIs) of the imbalance settlement process. eSett does market monitoring, customer support, reporting, and publishing of settlement results (including input data) continuously.

Contact info of eSett Oy

www.esett.com

settlement@esett.com

Phone +358 10 5018500



Operating hours during working days: 9:00 –
15:00 (CET)

2 Nordic Imbalance Settlement Model

This chapter presents the Nordic Imbalance Settlement Model and its functions in more detail. The roles and responsibilities of the different market participants and the concepts of balance responsibility and legal agreements related to it.

The purpose of imbalance settlement is to establish a financial balance in the electricity market after the operation hour. Imbalances are calculated for each BRP based on the PX market trades, bilateral trades and on realised consumption and production. Each BRP is financially liable for the imbalances under its responsibility, balanced by the balancing power procured from the balancing power market operated by the TSOs.

The Nordic Imbalance Settlement Model is based on the harmonised model with single imbalance which is calculated and settled. At the core of the Nordic Imbalance Settlement Model is the common operational unit (eSett) which is responsible for imbalance settlement. eSett performs services on behalf of the four TSOs.

The imbalance settlement agreement is a legal contract that defines eSett's and the BRP's liabilities, the BRP's collateral requirements and procedures for exclusion, and the legal items. The main stakeholders in the Imbalance Settlement Model are the Retailers (REs), the Balance Responsible Parties (BRPs), the Distribution System Operators (DSOs), the Balancing Service Providers (BSPs), the Transmission System Operators (TSOs), Nominated Electricity Market Operators (NEMOs), and eSett. The definitions of these stakeholders are presented in the list of terminology at the beginning of this Handbook.

The different procedures and operations of the Nordic Imbalance Settlement Model are divided into five core functions: settlement structure management, metering and reporting data, settlement, invoicing and reporting.

In addition, the Nordic Imbalance Settlement Model includes separate functions for collateral management and market behaviour monitoring.

2.1 The Imbalance Settlement Model

The Nordic Imbalance Settlement Model ensures a transparent and common imbalance settlement and equal treatment of market participants. The main objective of the Nordic Imbalance Settlement Model is to perform imbalance settlement across participating countries with the same principles and based on a single balance. The model provides harmonised and necessary procedures for imbalance settlement:

- **Settlement structure** defines how the information about the imbalance settlement structure and hierarchy (relations) is collected and managed, e.g. information about a new Metering Grid Area (MGA) or the contact information of a market participant. See Chapter 3, Settlement structure management
- **Metering** defines the different data types and the basis of the settlement data metering. See chapter 4, Metering
- **Reporting data** handles the imbalance settlement data reception, validation, storing and reporting by eSett. See chapter 5, Settlement data reporting
- **Settlement** handles the imbalance settlement calculations, quality assurance and publishing of results. See chapter 6, Imbalance settlement
- **Invoicing** handles eSett's invoicing of BRPs, based on realised imbalances and BSPs based on balancing services. See Chapter 8, Invoicing

- **Collateral management** includes control of the BRPs' collateral demands, as defined and calculated by eSett, as well as follow-up of the placed collateral deposits in comparison to demands. See Chapter 9, Collateral and risk management
- **Communication** presents different communication channels and an arrangement of the communication in Nordic Imbalance Settlement model. It also includes the creation, distribution and publishing of various reports and files provided by eSett. Reporting is also done through the Online Service, the Messaging Service and the Information Service that are provided to market participants. See Chapter 10, Communication
- **Market behaviour monitoring** is based on the analysis of the BRPs' imbalances. These are analysed by calculating a set of KPIs, which show the BRPs market performance (e.g. quality of reported data, reporting frequency, relative imbalances, absolute imbalances and imbalance costs per unit). The quality of DSOs reporting will also be monitored. See Chapter 11, Market behaviour reporting

All functions in the settlement model are described in **Figure 2** below.

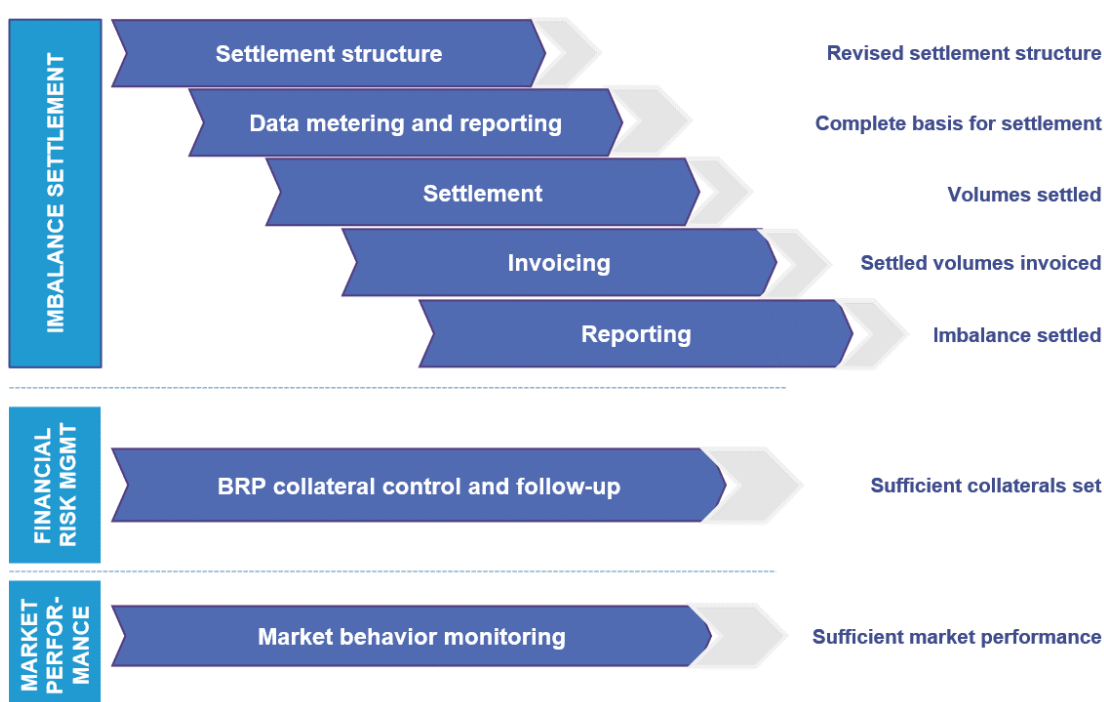

Figure 2. The Imbalance Settlement Model functions.

2.2 Roles, Responsibilities and Requirements

The main stakeholders (i.e. market participants) in the Nordic Imbalance Settlement Model along with the related roles and responsibilities are presented in the sections below. The validity of a market participant (i.e. the time frame within which the market participant is considered to be active in the market) shall be set after the required documents have been received by eSett. There are gate closures before a new market participant can be active in the Nordic market and they are presented in **Table 5** in this document.

2.2.1 Imbalance Settlement Responsible (eSett)

eSett is responsible for the financial settlement of imbalances in accordance with the imbalance settlement agreement and the Handbook:

- Collecting and maintaining the imbalance settlement structure
- Performing the imbalance settlement and invoicing/crediting the BRPs for the balancing power

- Invoicing/crediting the BSPs for the balancing services
- Setting the collateral levels so that they cover the imbalance settlement related risk exposure
- Collecting and monitoring the BRP's and BSPs collaterals and taking necessary action to adjust collaterals when needed
- Collecting fees from BRPs and BSPs to cover:
 - Balance management and settlement costs of the TSOs
 - A share of the reserve costs and related operational costs for the TSOs
- Monitoring imbalances and assessing whether they are in accordance with published guidelines and regulations
- Operating and providing an imbalance settlement IT solution available for the market participants can use to access and report settlement data
- Report and publish imbalance settlement data including statistics, KPIs and other market information

2.2.2 Transmission System Operator (TSO)

The TSOs have the ultimate responsibility to supervise the physical balance of the electricity system and to take actions in order to rebalance the system.

- Balancing the production/import with the consumption/export during the delivery day to meet the overall demand of a system frequency at 50 Hz
- Calculating imbalance adjustment volumes per imbalance settlement period and determining imbalance prices
- Submitting necessary information per BRP and per BSP to eSett for the imbalance settlement; e.g. production plan and activated imbalance adjustment during the imbalance settlement period
- Acting as the financial counterparty towards the BSP for all reserve capacity allocation (eSett is the financial counterparty for the corresponding activated reserves related to the imbalance settlement)
- Reporting to eSett the structural information of MBA, MGA and the relation between them.

2.2.3 Distribution System Operator (DSO)

A DSO is a grid operator with the responsibility to connect producers and consumers to its grid. The DSOs have the responsibility to meter production, consumption, and exchange with other grids and to report the metered data to the entitled parties. This includes closed distribution system operators. The DSO has several obligations in relation to imbalance settlement. Some of the DSOs' responsibilities towards eSett can be transferred to separate Metered Data Aggregator, e.g. to a national hub. Role of Metered Data Aggregator is explained in chapter 2.2.9. The DSO's responsibilities are as follows:

- Registering the REs' metering points regarding production and consumption in the respective MGAs
- Operating the metering system and submitting the required metering data to the REs, BRPs, TSO and eSett²
- Calculating and reporting load profile shares (according to national guidelines)
- Calculating the final profiled consumption and the reconciled energy when all metering for a grid area is completed (according to national guidelines, see sub chapter 6.6, Reconciliation)

² DSO's have responsibility to report BRPs' metering data to eSett. The responsibility is defined through the legislation and directives by the authorities in each country. eSett will have no duty nor practical possibility to ensure the correctness and completeness of the settlement information

- Imbalance corrections, after the imbalance settlement reporting is closed, shall be settled between the DSO and RE. The exact procedure for settlement of imbalance corrections will be developed by the energy industry in each country.

This kind of metering responsible party can be a party having DSO network licence or closed network licence or is registered as a metering responsible. If there is not a clear responsible participant for metering and reporting settlement data of the special metering grid areas (e.g. production or industrial metering grid areas) then a balance responsible party or an open supplier for this metering grid area is responsible for metering and reporting imbalance settlement data. These metering responsables shall have a role as a DSO in the Nordic Imbalance Settlement.

All Finnish DSOs in the Nordic Imbalance Settlement need to register their own metering grid areas to Fingrid as a TSO.

In Sweden, market participants that have a concession for a line or area have to be approved by the National Energy Authority in order to have a role as a DSO.

In Norway, a trading licensee who owns a transmission grid or is responsible for network services can have a role as DSO. Network services are defined as one or more of the following:

1. transmission of power, including operation and maintenance of and investment in grid installations
2. tariffing
3. metering, settlement, and customer service
4. supervision and safety
5. co-ordination of operations
6. required contingency measures
7. required power system planning.

2.2.4 Balance Responsible Party (BRP)

A BRP is a market participant having a valid agreement with eSett and the TSO of the area of operation. The BRP's responsibilities are defined in the balancing agreement, imbalance settlement agreement and in the Handbook:

- Having a valid imbalance settlement agreement with eSett and providing the required collaterals
- Planning balanced schedules per imbalance settlement period
- Submitting plans per RO to the TSO
- Submitting bilateral trade information to eSett and verifying the correctness of the bilateral trades submitted by its counterparts, also on RE level
- Acting as the financial counterpart for the settlement of imbalances and reconciliation according to national guidelines
- Acting as the financial counterpart for the balancing services in case the BRP has also a BSP role
- Keeping the imbalance settlement structure information up to date
- Verifying all relevant data reported by eSett, and notify deviations
- Informing eSett of which REs that the BRP is responsible for, for consumption and production per MGA

A BRP that has a valid agreement with a TSO regarding balancing services, does automatically also hold the market role and obligations of a BSP (see chapter 2.2.5 Balancing Service Provider (BSP)).

2.2.5 Balancing Service Provider (BSP)

A BSP is a market participant having a valid agreement with eSett and the TSO of the area of operation. The BSP's responsibilities are defined in the agreement(s) with TSO, agreement with eSett and in the Handbook:

- Having a valid agreement with eSett and providing the required collaterals
 - If there is already a valid BRP agreement with eSett for the same business entity, there is no need for a separate BSP agreement.
- Acting as the financial counterpart for the balancing services if the BSP does not have also a BRP role
- Keeping the imbalance settlement structure information up to date
- Verifying all relevant data reported by eSett, and notify deviations

2.2.6 Retailer (RE)

An RE is market participant that for example sells electricity to final consumers, purchases production or performs trade activity. The RE's responsibilities regarding imbalance settlement is as follows:

- All REs operating within the countries involved in Nordic Imbalance Settlement have to register to eSett according to the gate closure specified in **Table 5**.
- Having an agreement with a BRP for production and consumption in all MGAs where the RE is operating
 - For Finland this requirement will be adapted in order to facilitate the chain of open suppliers. This model allows that a RE may have an agreement with a BRP, or with another RE who then has an agreement with a BRP. This is illustrated in **Figure 3**.

The BRP will be responsible for and carry out the settlement of the REs under it's balance responsibility

eSett will carry out the BRP's imbalance settlement based on the DSO's delivery information. Imbalances will be calculated on BRP level

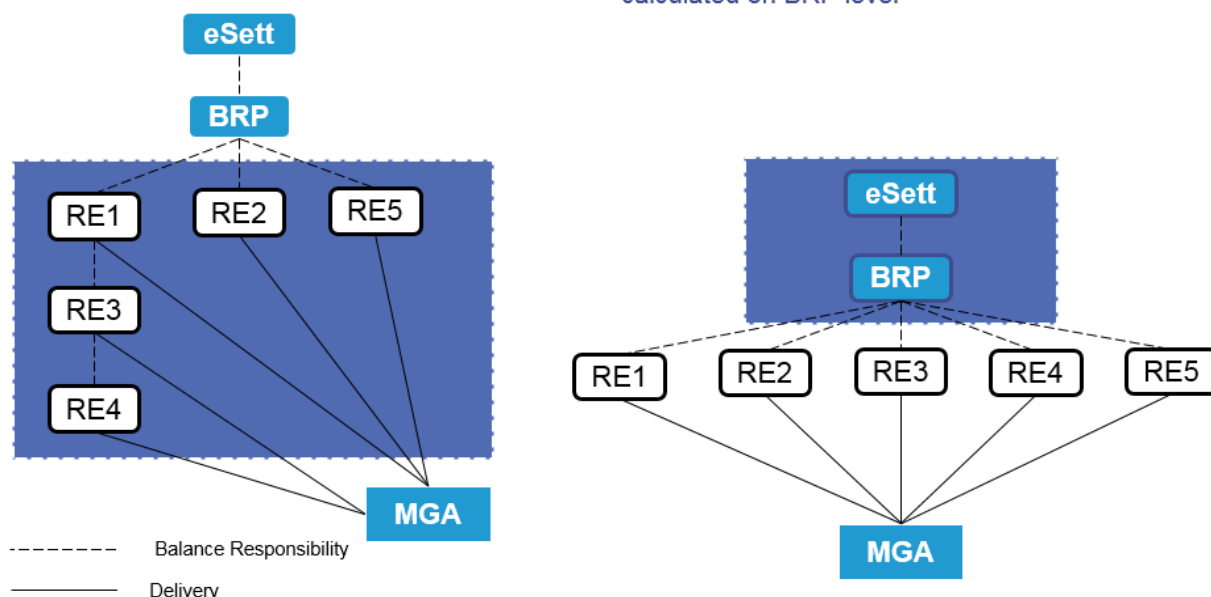

Figure 3. Handling the “chain of open delivery” in the Finnish market area.

- An RE can use one BRP for consumption and one BRP for production in the same MGA and use different BRPs in different MGAs. This division is highlighted in the following **Figure 4** where Finland is used as an example.

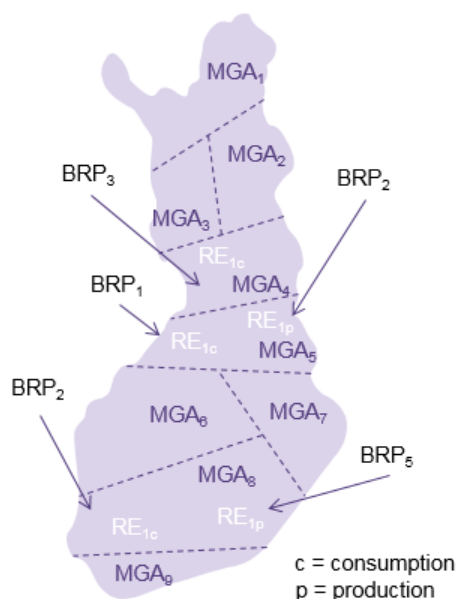

Figure 4. An illustrated model of one Retailer using different BRPs per MGA.

2.2.7 Nominated Electricity Market Operator (NEMO)

The responsibilities of a Nominated Electricity Market Operator, in its role as a power exchange and in regard to imbalance settlement are as follows:

- Reporting trade data for Day ahead - and Intraday trades (PX market trades) per RE and MBA to eSett (and TSO where needed).
- Reporting cross border trade (PX market flows) with other power exchanges (market coupling) to eSett and TSOs.
- Reporting exchanges between NEMOs (Bilateral trades) per MBA to eSett.
- In addition, Nominated Electricity Market Operator, in its role as power exchange, conducts market surveillance and reports any suspected breach of applicable regulations by the market participants to the national regulators.
- Each NEMO may delegate the performance of tasks related to balance responsibility as laid down in the captioned Imbalance Settlement Agreement and Balance Agreement(s) to the Central Counter Party (CCP) of the NEMO.

2.2.8 Service Provider (SP)

A Service Provider provides operational balance management and settlement services for the market participants e.g. the BRPs, BSPs, REs and DSOs. According to the services provided for the market participants, the service provider has a right to perform the corresponding tasks towards eSett and the imbalance settlement system.

The service provider can for example provide services below:

- reporting and entering settlement data
- verifying calculated imbalances or
- handling collateral management on the online service on behalf of the market party.

One market party can have several Service Providers (a separate Service Provider for each category) and one Service Provider can serve several market parties.

2.2.9 Metered Data Aggregator

A Metered Data Aggregator receives metered data from Distribution System Operator and reports aggregated values to eSett instead of DSO. National hubs will act as Metered Data Aggregators for DSOs in their operating countries. Before the start of national hub, DSO will aggregate its metered data and report it directly to eSett. Responsibilities of Metered Data Aggregator include:

- Registering the REs' production and consumption MECs in the respective MGAs
- Receiving metered and profiled data and calculating of aggregated consumption and production time series per MGA
- Reports aggregated time series to eSett

2.3 Calendar and Time Zones

The Nordic Imbalance Settlement Model utilises a combined Nordic calendar, which consolidates the public national holidays from all involved countries. You can find the calendar on eSett's homepage and in Appendix 2, Nordic Calendar. No invoicing shall be performed during a public holiday, and they will be taken into account in the terms of payment in settlement related invoicing.

As an example, if a certain day is considered as a public holiday in Sweden, it will also be considered a public holiday in all involved countries.

The Nordic Imbalance Settlement Model will be operated in Central European Time (CET)/Central European Summer Time (CEST) and a 24-hour clock (10 o'clock in the evening will be written as 22:00) in operation (for example in invoicing and imbalance settlement), which is required to be supported by all market participants acting with eSett. The Nordic Imbalance Settlement Model will also use winter and summer time change, last Sunday in March will have 23 hours and last Sunday in October will have 25 hours.

The settlement structure management (e.g. retailer balance responsibility, RBR) will be complied with national legislations. In Finland, the settlement structures will be managed in Eastern European Time (EET)/Eastern European Summer Time (EEST) and in Sweden the settlement structures are managed in Swedish Normal Time (SNT). In Denmark and Norway Central European Time (CET)/Central European Summer Time (CEST) is used.

2.4 Imbalance Responsibility and Agreements

Participating as a BRP in the electricity market settled by eSett requires a valid Balance Agreement between the BRP and the respective TSO, as well as valid Imbalance Settlement Agreement between BRP and eSett. Similarly, participating as a BSP in the electricity market settled by eSett requires a valid agreement on providing balancing services between the BSP and the respective TSO, as well as a valid Balancing Service Settlement Agreement between BSP and eSett unless the BSP already has a valid Imbalance Settlement Agreement for the same business entity.

The scope of the imbalance settlement agreement and balancing service settlement agreement are limited to issues regarding the settlement and invoicing of imbalances and balancing services. The TSO agreements regulate balance management, provision of balancing services and related issues.

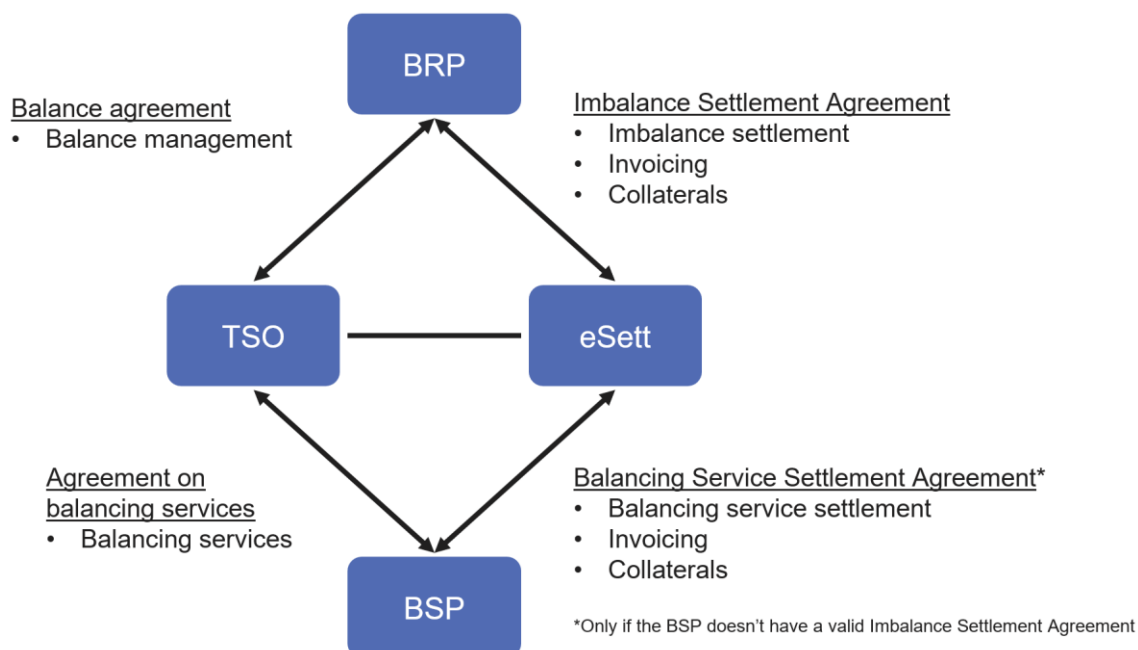

Figure 5. BRP and BSP agreements.

As before, a BRP or BSP must comply with the TSOs requirements if they are providing reserves in the balancing markets.

In addition, BRPs and BSPs need to hold a bank account(s) in an approved settlement bank, i.e. a bank which has been approved by eSett to be used in the settlement. See chapter 8.4 for the required banking setup and related agreements.

2.4.1 Imbalance Settlement Agreement

The Imbalance Settlement Agreement between eSett and BRP regulates the relations between the parties and the settlement requirements that the BRP must comply with. The following topics are included in the imbalance settlement agreement:

- BRP's rights and obligations
- eSett's rights and obligations
- Fees and taxes
- Invoicing and payment process and requirements
- Collaterals procedures and obligations
- Imbalance settlement rules as defined in the Handbook
- Parties' contractual liability
- Procedures when the agreement is breached by the BRP
- Term and termination of the agreement
- Procedures when the agreement and its appendices are amended
- Dispute resolution and governing law

2.4.2 Balancing Service Settlement Agreement

The Balancing Service Settlement Agreement between eSett and BSP regulates the relations between the parties and the settlement requirements that the BSP must comply with. The following topics are included in the balancing service settlement agreement:

- BSP's rights and obligations
- eSett's rights and obligations
- Fees and taxes
- Invoicing and payment process and requirements
- Collaterals procedures and obligations
- Settlement rules as defined in the Handbook
- Parties' contractual liability
- Procedures when the agreement is breached by the BSP
- Term and termination of the agreement
- Procedures when the agreement and its appendices are amended
- Dispute resolution and governing law

2.4.3 Entering into Agreement

In order to enter into agreement with eSett and the TSO(s), the BRP or BSP shall contact eSett for more information. Valid imbalance settlement agreement or balancing service settlement agreement, the appendices and contact information can be found on eSett's web site.

2.4.4 Termination of Agreement

Each party has the right to terminate the agreements with eSett and the TSO(s) according to what has been specified in each agreement.

The terms, under which eSett and TSOs shall have the right to terminate the agreements with eSett and the TSO(s), have been specified in each of the agreements. If a BRP or BSP acts against the rules of the agreements, following steps will be taken by eSett and TSO(s).

1. eSett and TSO shall inform each other and assess the situation together.
2. eSett or TSO shall inform the party of breach of agreement(s) and possibly
 - a. request for explanation for the breach of contract
 - b. give a deadline within which the situation must be corrected.
3. TSO may inform the national regulator, eSett and NEMOs that exclusion is possible. (Only in Norway.)
4. After an analysis, TSO has the right to decide whether an immediate termination of agreement is needed or not.

In case of termination of agreements with immediate effect, and thus causing a BRP to become a subject to exclusion from the market, the processes hereinafter are followed.

5. eSett or TSO shall inform the party of the decision and market exclusion.
6. eSett or TSO shall inform the national regulator, NEMOs, DSOs and affected REs about the exclusion.

7. Information shall be published via eSett and possibly also via TSO and/or national regulator.

In case of a market exclusion of a BRP, there are some national differences for the handling of the affected retailers, which have been described in the sub-chapters below.

2.4.4.1 Handling of Affected Retailers in Denmark

The affected retailers must sign a contract with a new BRP to effectuation within 3 days after the information from Energinet. During the period from the BRP market exclusion until the contract with a new BRP becomes valid, Energinet will operate as a BRP for the retailer. eSett will help to establish the necessary setup in the imbalance settlement system. If a retailer fails to get a contract with a new BRP within the time frame, Energinet will distribute the retailer's metering points to other retailers.

2.4.4.2 Handling of Affected Retailers in Finland

DSOs will stop the deliveries and distributions of a retailer that does not have an open supplier or a BRP. However, a DSO cannot stop the deliveries to the end users due to reasons of the retailer before the DSO has informed the end users about the termination. DSOs will guarantee the deliveries to the end users at least 3 weeks after the announcement of termination. If the DSO has not pointed out other open supplier, deliveries will be part of the MGA losses.

2.4.4.3 Handling of Affected Retailers in Norway

The affected retailers in Norway will be excluded if they are unable to obtain a new BRP immediately. DSOs will act as a supplier of last resort for the end users of the retailers that are excluded.

2.4.4.4 Handling of Affected Retailers in Sweden

The affected retailers have 10 working days and at most 15 calendar days to obtain a new BRP. During the period from the BRP market exclusion until the contract with a new BRP becomes valid, Svenska kraftnät will operate as a BRP for the retailer. If a retailer fails to get a contract with a new BRP within the time frame, DSO should replace the retailer with the retailer of last resort.

2.5 Company Data Model

This chapter shall clarify the different options the market participants have when organising themselves for the imbalance settlement model. As previously mentioned, the purpose of the imbalance settlement model is among other things meant to lower the barriers for operating in more than one country. However, national laws and the imbalance settlement system set certain requirements and limitations under which the market participants are expected to act. Company data model ties important concepts together by connecting the country, company, market participant role, collaterals, invoices, balance account, agreements, coding scheme and the related market participant code. In principle, there are three different ways to act in several countries and these possibilities are demonstrated in the following with the help of an illustrative table, which presents the case of a BRP. This chapter refrains from favouring any of the presented options and it is thus left for each company to consider and choose an option they deem to be most suitable for themselves.

Data model example: organization in two countries								
#	Company	BRP-role	Collateral	Invoice	Settlement account	Imbalance Settlement Agreement with eSett	Balancing Agreement with TSO	Market Participant Code
1.	2	2	2	2	2	2	2	2
2.	1	2	2	2	2	1	2	2
3.	1	1	1	2	1 - 2	1	2	1

Table 1. Company data model in NBS.

The first option in the above table describes a situation where two separate companies with their own business IDs are established, or already exist, in order to operate the BRP roles in two different countries. In practice, this set-up means that both of the market participant roles will have their own collaterals, separate invoices, and their own settlement accounts with eSett, one agreement with both TSOs and eSett depending on the countries the BRPs operate in, and finally, their own separate market participant codes, which are used, e.g. for messaging. In this case, these codes may follow the local coding schemes when operating only in one country. The agreements here are the Imbalance Settlement Agreement with eSett and the Balancing Agreements with TSOs. In this option, the companies are registered in different countries.

The second option is based on only one company having two separate BRP roles. This results in two separate collaterals, invoices, settlement accounts, agreements and market participant codes.

In order to prevent a situation where it is necessary to place several collaterals, the third option could be considered. This option gives the possibility to organise the company structure based on only one company and one BRP role, which operates in more than one country. However, differences in legislation between countries set limitations to this scenario in case the company is active in Norway. Due to Norwegian legislation, it is mandatory that in this option the company is registered in Norway since it is required that BRPs acting in Norway are locally registered companies.

One market participant role results in one set of collaterals as they are role-specific. In this scenario, the company will receive as many invoices as there are countries where the BRP operates since the invoice is always country-specific. The number of required settlement accounts depends on the number of currencies used, which means that if the BRP uses one common currency it is sufficient to have only one settlement account. For agreements, the same applies as to collaterals: they are role-specific. Logically, one BRP role requires only one market participant code as long as it is not any of the national codes, but either the EIC or GS1 code. However, it is mandatory to use Norwegian GS1 codes for market participant roles related to Norwegian companies.

3 Settlement Structure Management

Chapter three presents the settlement structure and hierarchy management in the Nordic Imbalance Settlement Model. It describes the reporting responsibilities and the rules and guidelines for reporting changes in the structural information as well as reporting schedules and methods.

The settlement structure is one of the key elements in the Nordic Imbalance Settlement Model. Each market participant is responsible for informing and updating structural information. Structural information is information about the market participants and their relations to each other (e.g. the relationship between a BRP and an RE) and to the Market Entities and Market Entity Connections (e.g. the relationship between an RE and an MGA). Every market participant has to register for acceptance to operate in the market. The participants themselves are responsible for registering and keeping their own information up-to-date.

Every company taking part in imbalance settlement needs to register in the imbalance settlement system. Company information will be registered together with information about the different roles that the company operates. A company can have several different roles (BRP, BSP, DSO, RE). Every role

the company operates will be registered as a market participant. It is also possible for a company to have multiple market participants of the same role.

eSett will maintain the structure information, based on the information provided by the DSOs, BRPs and TSOs. The DSOs are responsible for updating the structure related to metering points in the MGAs they are accountable for (e.g. a retailer's consumption and production within a MGA) and the BRPs are responsible for updating the structure of their obligations (e.g. which RE in the different MGA they are responsible for).

The market participants shall enter changes in the settlement structure in the Online Service, provided by eSett. The changes are validated and approved after they have been entered in eSett's imbalance settlement system. Once the changes are approved, they will be used in imbalance settlement. The structure information is published in the Online Service where market participants can view the up-to-date settlement structure information. Restrictions to view are managed with access rights in accordance with the legislation.

Furthermore, market participants will also be able to view and download the area-specific structure for all countries, i.e., information for MGA master data, MBA master data, MGA-MGA relations and MGA-MBA relations. The content of the MGA and MBA master data will be area-specific information, such as type, name, area identification, etc.

3.1 Settlement Structure

Up-to-date structural information is essential for managing the reporting and other imbalance settlement functions. The settlement structure contains the information related to different market participants: TSOs, DSOs, BRPs, BSPs and REs, and information on the relationship between the market participants.

Information regarding the BRPs' responsibility for an RE in all MGAs, and the specific period of time, is essential to enable correct reporting of data and calculation of imbalances. One common and public overview with this information is therefore developed and maintained in eSett's imbalance settlement system.

Every entity of structural information has a validity period. The given start and end date define the period of time during which the specific entity is considered to be active. The end date is not required when creating a new structure, but it shall be entered when the end date has been confirmed.

A description of the structure elements and their relations are available in **Figure 6**.

A detailed description of the interface and the process of managing the structural information will be provided as a User Guide in the Online Service.

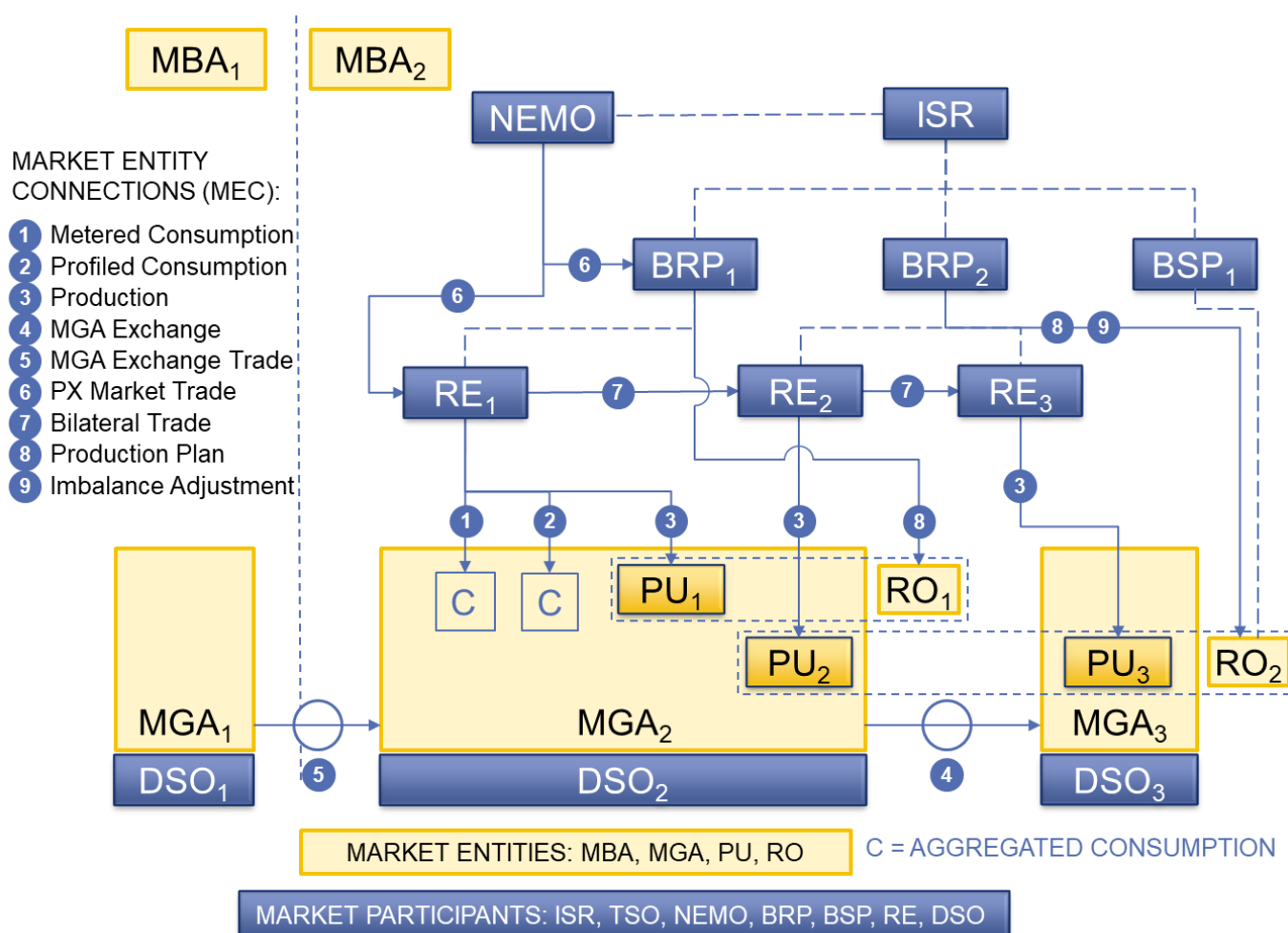

Figure 6. An illustrative example of the structure elements and their relations.

3.2 Market Participants

Information about the settlement structure is related to different types of roles (RE, BRP, BSP, DSO and TSO). One company may have multiple roles, and each of these roles shall be presented by a separate Market Participant operating in the electricity market. It is also possible for a company to have multiple market participants with the same role. In the Nordic Imbalance Settlement Model, there is always a connection between the structure information and specific market participants, being valid for a specified period of time. The roles are defined and described in the **Table 2** below.

Market Participants		
Name	Abbreviation	Description
Balance Responsible Party	BRP	A Balance Responsible Party is a party that has a valid imbalance settlement agreement proving financial security and identifying balance responsibility with eSett. Balance Responsibility means obligations to ensure that a balance exists between the supply and withdrawal and for the purchase and sale agreements it has entered into.
Balancing Service Provider	BSP	A company that has a valid agreement with eSett and a TSO about providing Balancing Services to a TSO. A balancing service provider means a market participant with reserve-providing units (e.g. production units) or reserve-providing groups (regulation units) able to provide balancing services to TSOs.
Distribution System Operator	DSO	A Distribution System Operator is the distribution grid owner with the responsibility to distribute electricity from producers to its customers. The DSOs have the responsibility to meter production, consumption, exchange and report the metered data to the involved stakeholders. This responsibility also includes closed distribution system operators.
Transmission System Operator	TSO	A Transmission System Operator has the responsibility for both the security of supply and the high-voltage grid. They also carry the ultimate responsibility on the imbalance settlement according to the national laws. In this document TSO refers to following Nordic TSOs: Energinet, Statnett, Fingrid, and Svenska kraftnät.
Retailer	RE	A Retailer sells electricity to an end user. It sells and buys electricity directly from a producer, another retailer or via Nominated Electricity Market Operator. A Retailer has an agreement with a BRP. In Finland, a Retailer may have an agreement with a BRP, or with another Retailer who then has an agreement with a BRP (chain of open suppliers, see 2.2.6).

Table 2. *The Market Participants in the Nordic Imbalance Settlement Model.*

3.2.1 Unbundling Rule

Unbundling rules define the roles that can be performed by a single company. Currently, there are some national differences in this legislation that will impact imbalance settlement.

Unbundling rules in Sweden, Denmark and Finland define that REs and DSOs must belong to separate companies. The only exception is Finland where DSOs with non-concessional grid (e.g. production and industrial metering grid areas) can belong to the same company as the RE.

A company operating in Norway may currently inhabit all roles if the company has fewer than 100,000 grid customers. This legislation is currently under consideration and may be subject to change. A DSO responsible for supply of last resort to end users is also obliged to register a separate Market Participant as an RE for this activity. This RE will also be used for the purchase of grid losses in cases where the DSO performs this activity itself. This Market participant may also be registered as a BRP if the DSO so wishes.

3.3 Market Entities

In order to organize the settlement information in a structured way, the structure information is also related to a market entity (ME). These are used to further specify the areas where consumption, trade and exchange occur, including also the power generator and regulation object. The defined MEs and the corresponding descriptions are shown below in **Table 3**.

Market Entities		
Name	Abbreviation	Description
Market Balance Area	MBA	An area within the power system that works as an imbalance area in which an imbalance is calculated. In NBS model an MBA is equal to a bidding zone and scheduling area, and imbalance price area is equal to one or more MBAs. An imbalance price is always the same within an MBA.
Metering Grid Area	MGA	A Metering Grid Area is a physical area where consumption, production and exchange can be metered. An MGA can include both production and consumption but also only one of these. It is delimited by the placement of meters for period measurement for input to, and withdrawal from the area. It can be used to establish the sum of consumption and production with no period measurement and network losses. MGAs are decided on national level.
Production Unit	PU	Generator or a set of generators within the same power plant. PU are divided into two types, normal and minor. Normal refers in Finland to PU \geq 1 MW, minor to $<$ 1MW. The limit in Norway is 3 MW. All PU in Sweden are normal and the capacity needs to be \geq 1 MW. PUs will not be used in the Danish implementation of the NBS model before 2024.
Regulation Object	RO	A Regulation Object (RO) is a set of one or more generators and stations within a MBA, except for Norway and Denmark where RO may span more than one MBA. There can only be one BRP per RO and RO for production can only include production of a certain technology (wind, hydro, nuclear, etc.). BRP submits plans per RO to the TSO before the delivery day. RO is decided by the respective TSO.

Table 3. Market Entities in the Nordic Imbalance Settlement Model.

3.4 Market Entity Connections

A large amount of settlement information is exchanged between market participants within the Nordic imbalance settlement. The information is organised into so called Market Entity Connections (MEC). The MECs are central in the imbalance settlement structure as they facilitate reporting of all the time series with settlement data.

MECs are different kinds of connections either between market participants (e.g. bilateral trades between parties) or between market participants and market entities (e.g. market participant's metered consumption in MGA or market participant's production per Production Unit). MEC's time series data is the core of the imbalance settlement. **Table 4** explains the MECs utilised in the Nordic Imbalance Settlement Model.

Market Entity Connections	
Name	Description
Metered and Profiled Consumption	Metered and Profiled consumption per MGA per RE, except profiled consumption in Sweden which is per MGA and BRP, is used in imbalance settlement. Metered and Profiled Consumption is divided into the following types: Grid losses, Interruptible consumption, Industry consumption over 50 MW, Pumping, Pumped Storage, Energy Storage and PU own consumption.
Production	Production per PU used in imbalance settlement. Production is divided into two categories, normal and minor. Following production types are defined: hydro, onshore wind, offshore wind, nuclear, thermal, solar, energy storage and other.
Merged Production	Merged Production per MGA per RE is used in imbalance settlement. Merged Production is divided into two categories, normal and minor. All < 1 MW production in Sweden is reported as minor merged production. Following production types are defined: hydro, onshore wind, offshore wind, nuclear, thermal, solar, energy storage and other.
MGA Exchanges	The exchange of energy sum that occurs between Metering Grid Areas adjacent to each other. Measured in the border points and reported for each imbalance settlement period.
MGA Exchange Trade	The MGA exchange trade represents the volumes that must be traded due to exchange between MGAs in different MBAs. The DSO appoints a RE to handle this trade.
PX Market Trade	PX Market Trade is the electricity trade concluded on the NEMO – day-ahead or intraday.
PX Market Flows	PX Market Flows in NBS area consists of two parts: Day-ahead and Intraday flows. Day-ahead flow is the planned flow between two MBAs and resulting from day-ahead market trades. Intraday flow is net planned flow between the two MBAs resulting from intraday market trades.
Bilateral Trade	An electricity trade that has been agreed upon between two market participants.
Production Plans	TSO reports production plans received from BRPs on RO basis. The production plans are not part of imbalance settlement calculations.
Imbalance Adjustment	An energy volume representing the Balancing Energy from a BSP and applied by the Connecting TSO for an Imbalance Settlement Period to the concerned BRPs, for the calculation of the Imbalance of these BRPs.
MGA Imbalance	Sum of reported input to, and withdrawals (including network losses) from one MGA. The sum is zero when reported values are correct.

Table 4. *Market Entity Connections in the Nordic Imbalance Settlement Model.*

3.5 Reporting Responsibilities and Schedules

eSett receives structure information from market participants containing imbalance settlement structure information that should be added, updated, or closed in the imbalance settlement system. The structure information is entered via the Online Service and validated by eSett. When the settlement structure has been updated, eSett publishes the settlement structure to market participants in the Online Service.

Every participant in the electricity wholesale market will have to apply to eSett for acceptance into the settlement structure. The participants themselves are responsible for registering and verifying that their information is up-to-date. Responsibilities regarding the settlement structure information management are explained in the following sub-chapters.

3.5.1 eSett

eSett hosts the common settlement structure information. The related responsibilities are the following:

- Setting BRPs as active when the imbalance settlement agreement is set into force and related requirements are fulfilled (Appendix 1)
- Setting BRPs as inactive when the imbalance settlement agreement has been terminated
- Setting BSPs as active when the required agreements are set into force and related requirements are fulfilled (e.g. possible collateral)
- Setting BSPs as inactive when the required agreements have been terminated
- Setting DSOs as active when they fulfil all requirements as DSO (license from the local authority, ID, certificate, testing)
- Setting DSOs as inactive when DSOs activity has ended
 - The DSO has for example been merged with another DSO
- Setting REs as active when they fulfil the requirements set upon them by the regulators
 - Since an RE may have a different BRP in every MGA it's most efficient that eSett perform this control instead of many DSOs or BRPs controlling the same RE
 - An active RE will be able to handle consumption, trade and production
- Setting REs as inactive when their activity has ended

3.5.2 Retailer – RE

RE is responsible for reporting the following structure information to eSett:

- Registering company as an RE
- Retailer initiates the switch of supplier process. This process can only be initiated when the RE has a valid BRP in the MGA where the delivery will take place
- Update own contact information

3.5.3 Balance Responsible Party – BRP

BRP is responsible for reporting the following structure information to eSett:

- Registering company as a BRP
- If a BRP has a valid agreement with a TSO regarding balancing services, registering company also as a BSP
- Registering for which REs they take on the responsibility for production, and in which MGAs. It is the new BRP that is responsible for applying the correct structure
- Registering for which REs they take on the responsibility for consumption/trade, and in which MGAs. It is the new BRP that is responsible for applying the correct structure
- Manage MECs for bilateral trade for REs that they are responsible for. Registration of a bilateral trade needs to be done by one of the BRPs and the counterpart will then need to approve the registration of the bilateral trade with this BRP
- Assigning PU to the correct RO
- Provide the TSO with sufficient information to register ROs
- Update own contact information

3.5.4 Balancing Service Provider – BSP

BSP is responsible for reporting the following structure information to eSett:

- Registering company as a BSP
- Provide the TSO with sufficient information to register ROs
- Update own contact information

3.5.5 Distribution System operator – DSO

DSOs have the main responsibility in maintaining the correct and up to date settlement structure. DSO is responsible for reporting the following structure information to eSett, unless some of these responsibilities are taken over by a Metered Data Aggregator:

- Registering company as a DSO
- Updating the structure for consumption MECs within the MGA
 - Provide following information: Retailer, MGA, Consumption Type and Validity
- Updating the structure for merged production MECs within the MGA
 - Provide following information: Retailer, MGA, Production Type, PU Type and Validity
- Updating the structure for PU within the MGA
 - Provide following information: MGA, Production Type, PU Type, Validity, Production Unit ID and Capacity (nominal capacity of the PU)
- Updating the structure for production MEC
 - Assign a RE to the PU
- The DSO must select a RE for every MGA to handle the MGA imbalance
- Updating own contact information

3.5.6 Metered Data Aggregator

Metered Data Aggregator maintains the settlement structures related to DSOs. It can be for example a national hub which handles all reporting towards eSett and acts between DSO and eSett. Thus, Metered Data Aggregator handles several responsibilities instead of DSO. Their reporting to eSett includes:

- Updating the structure for consumption MECs within the MGA
 - Provide following information: Retailer, MGA, Consumption Type and Validity
- Assign Retailer for every MGA to handle the MGA Imbalance
- Updating the structure for merged production MECs within the MGA
 - Provide following information: Retailer, MGA, Production Type, PU Type and Validity
- Updating the structure for PU within the MGA
 - Provide following information: MGA, Production Type, PU Type, Validity, Production Unit ID and Capacity (nominal capacity of the PU)
- Updating the structure for production MEC
 - Assign a RE to the PU
- Updating own contact information

3.5.7 Nominated Electricity Market Operator – NEMO

NEMO is required to register as a BRP and RE in the settlement structure. In addition, NEMO is responsible for reporting occurred PX Market Trades. NEMO is responsible for reporting the following structure information to eSett:

- Registering company as a BRP
- Managing MECs for Day-ahead trades
- Managing MECs for Intraday trades
- Managing MECs for Day-ahead flows
- Managing MECs for Intraday flows
- Managing MECs for Bilateral trades
- Updating own contact information
- NEMO may delegate the performance of tasks related to balance responsibility to the Central Counter Party (CCP) of the NEMO. In that case, all the above-mentioned responsibilities are responsibilities of the CCP.

3.5.8 Transmission System operator – TSO

TSOs have, in addition to below mentioned responsibilities, the similar responsibilities as the BRPs (if applicable):

- Determining the MGAs
- Determining which MGAs that will be included in a MBA
- Managing MECs for MGA exchange
- Managing MECs for imbalance adjustment
- Managing ROs

3.5.9 Reporting Schedule and Gate Closure Times

The settlement structure information is to be registered according to the defined gate closure times. The gate closure times per responsible party are described in **Table 5**.

Gate closure times for updating structure information			
Structure information	Prerequisites/remarks	Responsible Party	Gate closure time
Consumption in MGA	<ul style="list-style-type: none"> • Valid MGA, RE and Retailer Balance Responsibility (RBR) for consumption 	<ul style="list-style-type: none"> • DSO 	<ul style="list-style-type: none"> • 7 days after the delivery day (if structure change is made on Monday, then it could be valid from the start of previous Monday) in Finland • 10 days after the delivery day in Sweden • 12 days after the delivery day (i.e. changes can be made for the open settlement period except for the closing day) in Norway and Denmark
Merged production in MGA	<ul style="list-style-type: none"> • Valid MGA, RE and Retailer Balance Responsibility (RBR) for production 	<ul style="list-style-type: none"> • DSO 	<ul style="list-style-type: none"> • Not used in Finland • 10 days after the delivery day in Sweden • 12 days after the delivery day (i.e. changes can be made for the open settlement period except for the closing day) in Norway and Denmark

Gate closure times for updating structure information			
Structure information	Prerequisites/remarks	Responsible Party	Gate closure time
MGA Imbalance Retailer	<ul style="list-style-type: none"> Valid MGA, RE and Retailer Balance Responsibility (RBR) for consumption 	<ul style="list-style-type: none"> DSO 	<ul style="list-style-type: none"> One (1) day before the delivery day (if structure change is made today, then it could be valid at the start of tomorrow) in Finland and Sweden 12 days after the delivery day in Norway and Denmark
Production Unit (PU)	<ul style="list-style-type: none"> MGA where PU locates to be valid 	<ul style="list-style-type: none"> DSO 	<ul style="list-style-type: none"> One (1) day before the delivery day for normal production in Finland 7 days after the delivery day for minor production in Finland 10 days after the delivery day for all production in Sweden 12 days after the delivery day for all production in Norway
Production Unit → Retailer (PU-RE)	<ul style="list-style-type: none"> RE must be valid RE must have agreement with BRP PU must be valid 	<ul style="list-style-type: none"> DSO 	<ul style="list-style-type: none"> One (1) day before the delivery day for normal production in Finland 7 days after the delivery day for minor production in Finland 10 days after the delivery day for all production in Sweden 12 days after the delivery day for all production in Norway
Bilateral trade	<ul style="list-style-type: none"> Valid BRP-RE structure 	<ul style="list-style-type: none"> BRP 	<ul style="list-style-type: none"> Three (3) full days before the delivery day
Regulation object	<ul style="list-style-type: none"> Provide the TSO with information regarding the allocation of PUs within the ROs Notify eSett of existing ROs 	<ul style="list-style-type: none"> BRP TSO 	<ul style="list-style-type: none"> 14 full days before the delivery day Three (3) full days before the delivery day
Production Unit → Regulation Object	<ul style="list-style-type: none"> PU must be valid RO must be valid PU and RO must be of same type PU and RO must be located on the same MBA 	<ul style="list-style-type: none"> BRP 	<ul style="list-style-type: none"> One (1) day before the delivery day for normal production in Finland 7 days after the delivery day for minor production in Finland 10 days after the delivery day for all production in Sweden 12 days after the delivery day for all production in Norway
RE → BRP structure (Retailer balance responsibility, RBR)	<ul style="list-style-type: none"> It must be known which BRP will be responsible for consumption and production in every MGA, where the RE will have activity MECs structures cannot be created in MGAs where the RE is without valid BRP Manual verification by eSett is required 	<ul style="list-style-type: none"> BRP (the RE's new BRP) 	<ul style="list-style-type: none"> Creation and change of RBR five (5) full days before the delivery day Termination of RBR 14 full days before the delivery day

Gate closure times for updating structure information			
Structure information	Prerequisites/remarks	Responsible Party	Gate closure time
Market participant validity (companies and market participant roles related to the respective company)	<ul style="list-style-type: none"> The validity of a market participant (i.e. the time frame within which the market participant is considered to be active in the market) shall be set after the requirements have been fulfilled by the market participants 	<ul style="list-style-type: none"> eSett 	<ul style="list-style-type: none"> Preconditions must be fulfilled 14 full days before market participant starts operation in the market
MGA	<ul style="list-style-type: none"> Valid DSO TSO is contacted about the new MGA Valid MGA code Valid MGA imbalance retailer 	<ul style="list-style-type: none"> TSO 	<ul style="list-style-type: none"> 14 full days before the changes are set active
MGA → MBA structure	<ul style="list-style-type: none"> Valid MGAs and MBAs TSO to divide MGAs to MBAs within a country 	<ul style="list-style-type: none"> TSO 	<ul style="list-style-type: none"> 14 full days before the changes are set active
MGA → DSO relation	<ul style="list-style-type: none"> Valid MGA and DSO 	<ul style="list-style-type: none"> TSO 	<ul style="list-style-type: none"> 14 full days before the changes are set active
MGA Exchange MEC	<ul style="list-style-type: none"> Valid MGAs 	<ul style="list-style-type: none"> TSO 	<ul style="list-style-type: none"> 7 full days before the delivery day

Table 5. Gate closure times for reporting structure information.

Example of the gate closure times for reporting structure information:

New RE that should be registered in the Nordic market:

1. The new RE shall provide eSett with required information to register the company. eSett register the new RE and set the RE as valid at the earliest starting from 14 days after all mandatory information has been provided.
2. From the day that eSett registers the new RE it will be available for the BRP to register the BRP-RE relation for the specific MGA. Valid start date can earliest be the same as new RE start date but not earlier than 5 days from when the BRP registers the responsibility.
3. When the BRP-RE relation is approved by eSett, the DSO will be able to submit the MGA structure (Consumption, Production). Valid from date can earliest be the same as the BRP-RE relation valid start date, given that the DSO submits the structural information.

Already registered and valid RE in the Nordic market:

1. A registered and valid RE is already available for the BRP in order to register the BRP-RE relation in the specific MGA. The BRP is required to enter the information at least 5 days prior to when it shall be in operation.
2. When the BRP-RE relation is verified by eSett, the DSO will be able to submit the MGA structure. Valid from date can earliest be the same as the BRP-RE relation valid start date, given that the DSO submits the structural information.

In the first example, the process will take at least 14 days. In the second example, the process will take at least 5 days.

3.5.10 Structure Information to the Market Participants

The published structure information in the Online Service will also be provided with an XML-file. **Table 6** shows an example of structure information regarding a DSO that will be provided via file. The example is based on the format of the settlement information that will be published on <https://ediel.org/>.

Document Identification	Document Type	Process Type	Sender Identification	Sender Role	Receiver Identification	Receiver Role	Creation Date Time
"Document001"	Z12	Z07	"eSett"	A05		A26	20151020
Party details							
Subject Party	Subject Party Role	Metering Grid Area Identification	Validity Start	Validity End	Business Type	Settlement Method	
	A12	MGA 1 (unique ID, e.g. LDG)	20151101		A04	E02	
	A12	MGA1	20151101		A72	E02	
	A12	MGA1	20151101		A15	E02	
	A12	MGA1	20151201		A04	E02	
	A12	MGA1	20151201		A04	E01	
	A12	MGA1	20160101		A04	E02	
	A08	MGA1	20151101		B29	E02	
Comment:							
Receiver Identification:	Identification of the party who is receiving the master data						
Subject Party:	Unique ID of the Retailer or Balance Responsible Party in question						
Subject Party Role:	Retailer or Balance Responsible Party						
Business Type:	Type of consumption						

Table 6. Structure report MGA example.

4 Metering

Chapter four presents the settlement data metering activities required to be performed by DSOs. It defines the different types of metered data, how these shall be handled by DSOs and how the metering data shall be validated, and sufficient quality ensured.

The Nordic Imbalance Settlement Model organises all metered data, exchange, consumption, and production, into MGAs. Each MGA is connected to a single MBA and DSO, thus connecting the metered consumption and production as MECs to the imbalance settlement structure.

Reporting of metering data (as further described in chapter 5) is considered as a responsibility of a DSO in the Nordic Imbalance Settlement Model, including the aggregation of data to RE level. eSett is responsible for aggregation of received metering data on a BRP level for imbalance settlement purposes.

Considering the critical role of the metering data from the imbalance settlement perspective, it is thus important to secure sufficient quality on reported data to ensure accurate

imbalance settlement, by minimising variations caused by data quality (e.g. missing or incorrect values) and its timely submission within specified gate closures. Therefore, the quality of reported data will be closely monitored by eSett and reported to related market participants by specific reports and KPIs (see chapter 11 for further information).

This chapter defines and describes the different types of metering data utilised in the Nordic Imbalance Settlement Model for exchange, production and consumption and how these are expected to be handled by the DSOs in order to report these to eSett.

MGAs are defined nationally by respective TSOs in accordance with national rules and legislation. Therefore, practices can differ between the countries participating in the Nordic Imbalance Settlement.

In Finland MGAs for imbalance settlement and for consumption and production have been defined in cooperation with Fingrid as a TSO, BRPs and DSOs. Every MGA has to have one responsible DSO for metering and reporting (licence for DSOs networks, licence for closed networks or agreed with Fingrid). There has to be one RE responsible for MGA imbalance within a one MGA.

In Norway the MGAs are defined by the imbalance settlement responsible with support from TSO and DSO. The DSO of the MGA must be responsible for metering and reporting of all metering points within the MGA. All metering points within the MGA must belong to the same MBA. In Norway, Elhub reports data to eSett instead of Norwegian DSOs.

In Sweden MGAs for imbalance settlement and for consumption and production have been defined in cooperation with Svenska kraftnät as a TSO. The principle is that the MGA is electrically connected, and the distribution is limited to one market balance area. Every MGA has to have one responsible DSO for metering and reporting. One RE is responsible for the losses within a MGA.

In Denmark MGAs for imbalance settlement have been defined in cooperation with Energinet as a TSO. Each MGA has a responsible DSO for metering and reporting of data within the MGA. There has to be one RE responsible for MGA imbalance within a one MGA. In Denmark, DSOs report data to Energinet DataHub, and they will report it to eSett instead of Danish DSOs.

4.1 Metered Data by Types

There are three different main types of metered data (or types of metering points) utilised in the Nordic Imbalance Settlement Model. The identified metering data types are the following:

- Exchange metering point to other MGAs:
 - Metered exchange with adjacent MGAs
- Production metering points:
 - Metered production per PU
 - Metered merged production within the MGA
- Consumption metering points:
 - Metered consumption from the MGA, divided into following subtypes:
 - Metered consumption
 - Pumped (only in Norway)
 - Pumped storage (only in Norway)
 - Interruptible (only in Sweden)
 - Industry over 50 MW (only in Sweden)
 - PU Own consumption (only in Finland). Production units' own consumption can be separated from the metered consumption by using this type
- Profiled consumption, divided into following subtypes:
 - Profiled consumption
 - Pumped (only in Norway)
 - PU Own consumption (only in Finland).
- Losses, may be divided into following subtypes:
 - Metered grid losses
 - Profiled grid losses
 - Flex-settled losses (Only in Denmark)
- Metered flex-settled consumption (Only in Denmark)

Losses shall be calculated in Finland as stated in chapter 5.4.2.4 and it's not required to separate losses for both metered and profiled losses (metered shall be used and reported to eSett).

The different consumption types are explained in more details in chapter 5.4.2.4.

It is to be noted that a number of country specific types of consumption metering points shall be utilised in the Nordic Imbalance Settlement Model as highlighted above.

4.2 Replace or Estimate Missing Values

eSett do not regulate how the estimation of missing measurement values shall be done. Practices differ between the countries today. Below information about the national principles has been provided.

The Finnish Energy industry's directions of how the missing values shall be estimated or replaced are presented in the document "Principles of electricity metering 2022". The document can be found at https://energia.fi/energiasta/energiamarkkinat/sanomaliikenne/ohjeet_ja_suosituksset.

The Swedish directions on how the missing values shall be estimated or replaced are presented in "Elmarknadshandboken". The document can be found at <http://elmarknadshandboken.se/Dokumentation/Texter/NEMHB.pdf>.

The Norwegian Elhub project has described the requirements for quality assurance that shall be performed by the DSO before reporting to Elhub. These requirements are presented as standards for validation, estimation and change of metered values. The Norwegian name of the document is "Standard for Validering, Estimering og Endring (VEE) av AMS måleverdier" and can be found at <https://elhub.no/>.

The Danish market regulation D1 "AFREGNINGSMÅLING OG AFREGNINGSGRUNDLAG" describes handling of and demands for estimation of missing values. The document can be found at Energinet's homepage with Market regulations: <https://energinet.dk/regler/el/elmarked/>.

4.3 MGA Exchange Meters and MGA Exchanges

The MGA exchange meters measure the energy flows between the adjacent Metering Grid Areas. The meters measure the exchange in the border points. The DSOs are responsible for the MGA exchange meters (e.g. reporting the values to the imbalance settlement).

The MGA exchange means exchange of energy sum that occurs between adjacent Metering Grid Areas. These sums shall be used in eSett's imbalance settlement. Both DSOs of the adjacent MGAs shall report the sums to the imbalance settlement, or the DSOs can agree that one of them shall report the sums.

4.4 Production Metering

All production metering in the Nordic Imbalance Settlement Model is based on netted metering. Netted metering is defined as metered production after own consumption used for power generation has been subtracted. Until legislation in Denmark, Finland, Norway and Sweden have been harmonised, the Nordic Imbalance Settlement Model will handle both gross and net metered production, which can be metered, aggregated and reported in accordance to principles defined below.

An industry site that also has its own production units are not allowed to net the production with their consumption. Production and consumption should be metered and reported separately to eSett's imbalance settlement.

The definition of own consumption has not been harmonized. Information about the national principles has been provided below:

- In Finland the legislation for own consumption of the production plant can be found in the document "Kauppa - ja teollisuusministeriön asetus voimalaitosten omakäyttölaitteista". The document can be found at: <http://www.finlex.fi>.
- In Sweden there is no legislation describing own consumption of the production plant.
- In Norway the definition of own consumption of the production plant can be found in the document "Forskrift om elsertifikater" in chapter 3 § 16 "Bestemmelser om måledata og korreksjonsfaktor".
- In Denmark rules for settlement metering of production in various cases, including handling of own consumption, is described in Market regulation D1 chapter 5 in combination with the document "RETNINGSLINJER FOR UDFØRELSE AF MÅLINGER TIL BRUG FOR NETTOAFREGNING". Both documents can be found at Energinet's homepage with Market regulations: <https://energinet.dk/regler/el/elmarked/>.

4.4.1 Description of Net Metering for Production

Net metering has been implemented so that both generator and own consumption of the production unit are metered by the same meter. This is illustrated in the **Figure 7** below. In this case, the meter is a so-called two-way

meter and it is possible to measure energy in both directions. If production energy exceeds the own consumption, it is reported as production. If there is no production during an imbalance settlement period, the own consumption will be reported as consumption (consumption type: PU Own Consumption).

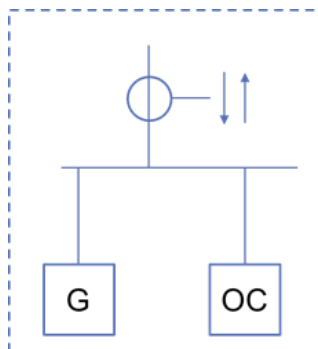

Figure 7. Net metering of production.

4.4.2 Description of Gross Metering for Production

Gross generation is defined as the sum of the electrical energy production by all the generating sets concerned, measured at the output terminals of the main generator. In **Figure 8** the principle of gross metering has been described. Meter 1 is for production metering and meter 2 is the metering of own consumption. Meter 1 will be the reported production of the PU. Metered values from Meter 2 will be aggregated together with other meters that the RE has in this MGA before it is reported to eSett.

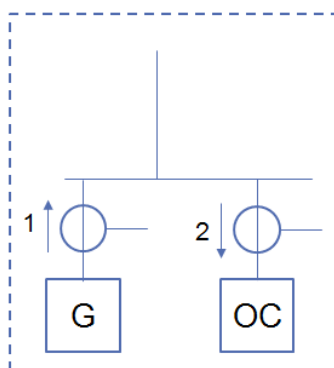

Figure 8. Gross metering of production.

4.4.3 Description of Households with both Production and Consumption “Prosumers” and Industry with Consumption

Net metering of PUs with own consumption and an additional consumption (C) may be set up according to **Figure 9** (no meter 2 is required for sites with main fuse up to 3x63A in Finland). The additional consumption (C) (e.g. a factory) may not be netted with the production. Only netting of own consumption behind meter 2 is allowed.

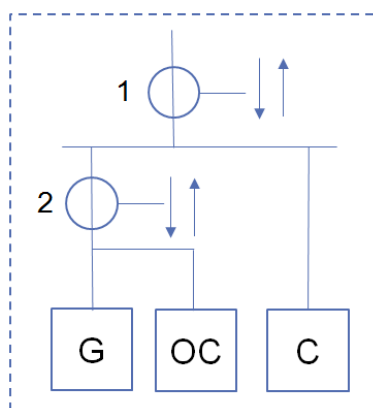

Figure 9. Meter for production, own consumption, and consumption.

Consumption (C) is calculated as: $C = (1 - 2)$

If the production (2) is ≥ 1 MW the production (2) shall be reported separate from consumption (C). If the DSO doesn't have this task the plant owner is obliged to organize the site as an own MGA and report production and consumption.

As defined above minor production (e.g. < 1 MW in Finland) can be netted with consumption e.g. in the case when there will be wind turbines and solar panels in a household level. This production will deduct consumption and can be netted with RE's aggregated consumption in the specific metering grid area. But when this kind of minor production exceeds RE's consumption in the MGA, it has to be reported separately. Practically (based on e.g. the data formats) the PUs for this kind of minor production need to be established and it's possible to create a virtual PU to all RE's minor production in a one specific MGA. It's always possible to report minor production and consumption separately.

In Finland, reserve power generators, energy storages or other low-power machines over 1 MW that are only intended for temporary use and disturbance management purposes are handled as above defined minor production.

4.5 Consumption Metering

The DSO should, in a settled meter point, meter values at each shift of imbalance settlement period. The DSO is recommended to perform data acquisition as soon as possible after the delivery day.

The handling of consumption metering will be done in accordance with existing national rules.

4.6 Energy Storages

There are not yet harmonized rules, but the main principles for the handling of energy storages are the same for all countries in the Nordic Imbalance Settlement. There are some national differences that are specified below.

The main principle is that an energy storage will be registered with two metering points; one for consumption for when the energy storage is charging, and another for production for when the energy storage is discharging. Netting between charging and discharging is not allowed for energy storages. A production plan is required for the discharging always in Denmark and Sweden, and also in Finland and Norway if the energy storage capacity is 1 MW or higher.

In Denmark, Norway and Sweden there are no specific rules for the metering of energy storages. It is handled according to the rules for Production metering (discharge) and Consumption metering (charge). Netting with other metering points is not allowed for energy storages.

The specific rules for Finland have been described in detail in chapter 4.6.1.

Table 7 compiles the cases for handling of energy storages in imbalance settlement per country and type.

Energy Storages				
Country	Type	Charging	Discharging	Production plan
Finland	Normal	Consumption metering point PU own consumption or netted with production (only with other production)	Production metering point Netted with production (only with other production) Netted with consumption (only temporary and disturbances)	Yes
	Minor (< 1 MW)	Consumption metering point	Production metering point Netted with consumption	No
Norway	Normal	Consumption metering point	Production metering point	Yes
	Minor (< 3 MW)	Consumption metering point	Production metering point	Yes if ≥ 1 MW
Sweden	Normal	Consumption metering point	Production metering point	Yes
	Minor (< 1 MW)	Consumption metering point	Production metering point	Yes
Denmark	Normal	Consumption metering point	Production metering point	Yes

Table 7. Handling of energy storages in different countries.

4.6.1 Handling of Energy Storages in Finland

In Finland, following rules are applied depending on the case:

- Energy storage with distribution/national grid:
 - Energy storage of 1 MW or larger
 - Discharging = Production
 - Charging = Consumption
 - Production plan is required for the discharging.
 - Energy storages that are used for disturbance situations or for temporary use, can be also netted with the consumption.
 - Under 1 MW energy storage
 - Discharging can be netted with the consumption of the retailer.
- Energy storage with other production:
 - When energy storage is connected to a power plant and the power plant is producing, charging of the energy storage can be handled as an own consumption. Charging and discharging of storage can be netted with the production of the plant.
 - If the Power plant is not producing, energy storage will be handled as in with distribution/national grid.
- Energy storage with consumption:
 - Under 1 MW energy storage can be netted with the consumption

- Energy storages with capacity of 1 MW or larger, that are used for disturbance situations or for temporary use, can be also netted with the consumption. Otherwise as in with distribution/national grid.

5 Settlement Data Reporting

Chapter five presents the settlement reporting activities. It describes the reporting responsibilities and time schedules for each of the market entity connections. Moreover, it describes the management of bilateral trade corrections and metering grid area exchange corrections.

The settlement data shall be reported to eSett via market messages or via Online Service. The reported data is further aggregated by eSett in order to establish the imbalance. Gate closure times differ depending on the data that is being reported. If one or more settlement data exceed the gate closure time, then the whole message will be rejected.

The metered data (production per PU, merged production data per RE and MGA, aggregated metered consumption data per RE and MGA, and MGA exchange data) shall be reported by the DSOs. The BRPs are responsible for reporting bilateral trades to eSett. They shall in addition report plans per RO and bids for up and down regulation to the TSOs. BRPs are also obliged to keep their plans updated, i.e. report updated values. Nominated Electricity Market Operator (NEMO) is responsible for reporting day-ahead and intraday trade results to the TSO

and eSett. TSOs also report reserves and prices to eSett.

eSett performs validations on received data and publishes it in the Online Service. The settlement calculations and the weekly invoicing are then performed in the imbalance settlement IT system.

The verification of the bilateral trades and MGA exchanges is performed by verifying that values reported by the two counterparts are equal. If the values do not match, they will be changed according to pre-defined correction rules and a notification will be sent to both counterparts. The parties may however decide that only one party will report the values.

In the Nordic Imbalance Settlement Model, the data is per imbalance settlement period, it is collected daily, reported within 2 days and updated within the stipulated 13 days. The reporting requirements for the DSO regarding the reporting flows and schedule are regulated by national laws.

5.1 Reporting Requirements

All reporting in the Nordic Imbalance Settlement Model shall be performed in accordance to the specification laid down in the market model for data exchange document Business Requirement Specification for Data Exchange in NBS (BRS). The latest version of the document can be found at the following address: <https://ediel.org/>.

This obligation is regulated as follows:

- Sweden: Regulated in the EDIEL-agreement between Market participants and Svk.
- Finland: Responsibilities are regulated in the secondary law and market participants should follow the instructions given by the TSO and instructions/procedures agreed in the energy field.
- Norway: Responsibilities are regulated in the secondary law and market participants should follow the instructions given in the Ediel User guide.
- Denmark: Responsibilities for reporting are regulated in Danish electricity market regulations.

The reporting shall be performed with the accuracy, signs and units in according to the description below. For information on the reporting time periods and gate closures see chapter 5.3.

In cases where service providers are used to report e.g. metered values on behalf of a DSO, it is to be noted that the formal responsibility still remains with the DSO in accordance to national legislation.

5.1.1 Unit and Accuracy

The unit of reported values can be kWh or MWh according to the BRS. The resolution is the maximum in watt-hour, i.e. a maximum of three decimals in kWh and a maximum of six decimals in MWh.

In the current state, there are national differences in terms of the use of units and decimals:

- Sweden: according to industry agreement, meter values shall be reported in kWh with up to three decimals. Rounding is not permitted.
- Norway: meter values shall be reported in kWh with up to three decimals.
- Finland: at their most accurate, the data can be transmitted as MWh with six decimals and as kWh with three decimals, i.e. with an accuracy of 1 Wh. This requirement is in accordance with the Finnish Energy's direction "Principles of electricity metering 2022" in chapter 8.2. The document is available at https://energia.fi/energiasta/energiamarkkinat/sanomaliikenne/ohjeet_ja_suositukset.
- Denmark: Meter values shall be reported in kWh with up to 3 decimals according to Market regulation D1.

5.1.2 Sign Handling

When reporting data to eSett, sign handling is given by the Business Requirement Specification for Data Exchange in NBS (BRS). When viewing data in the imbalance settlement system, the following will apply. Aggregated consumption and power exported from the MGA to an adjacent MGA will have a negative sign. Meter values from production units and import of power to the MGA from an adjacent MGA will have a positive sign.

5.1.3 Status of Reported Values

All reported meter values have to be marked with a status (Quantity Quality according to BRS) indicating the quality of the metered values. The default status for all values is "Metered, i.e. Quantity Quality is only used if the status is ≠ "Metered". The following statuses can be set in addition to "Metered".

- Temporary
- Estimated, approved for billing
- Does not exist (only used for meter values at the metering point level).

5.2 Reporting Data Flows

The figures below illustrate the reporting data flows and are divided into: reporting before delivery day, reporting after delivery day and reporting after the imbalance settlement is closed.

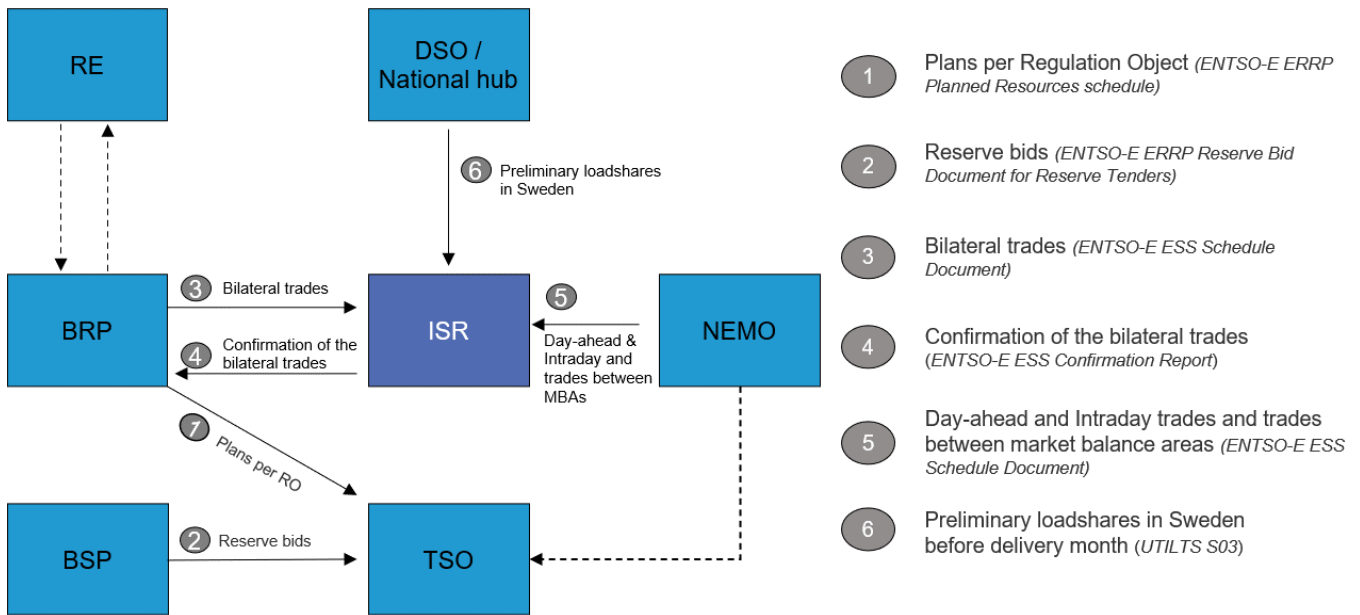

Figure 10. Reporting before delivery.

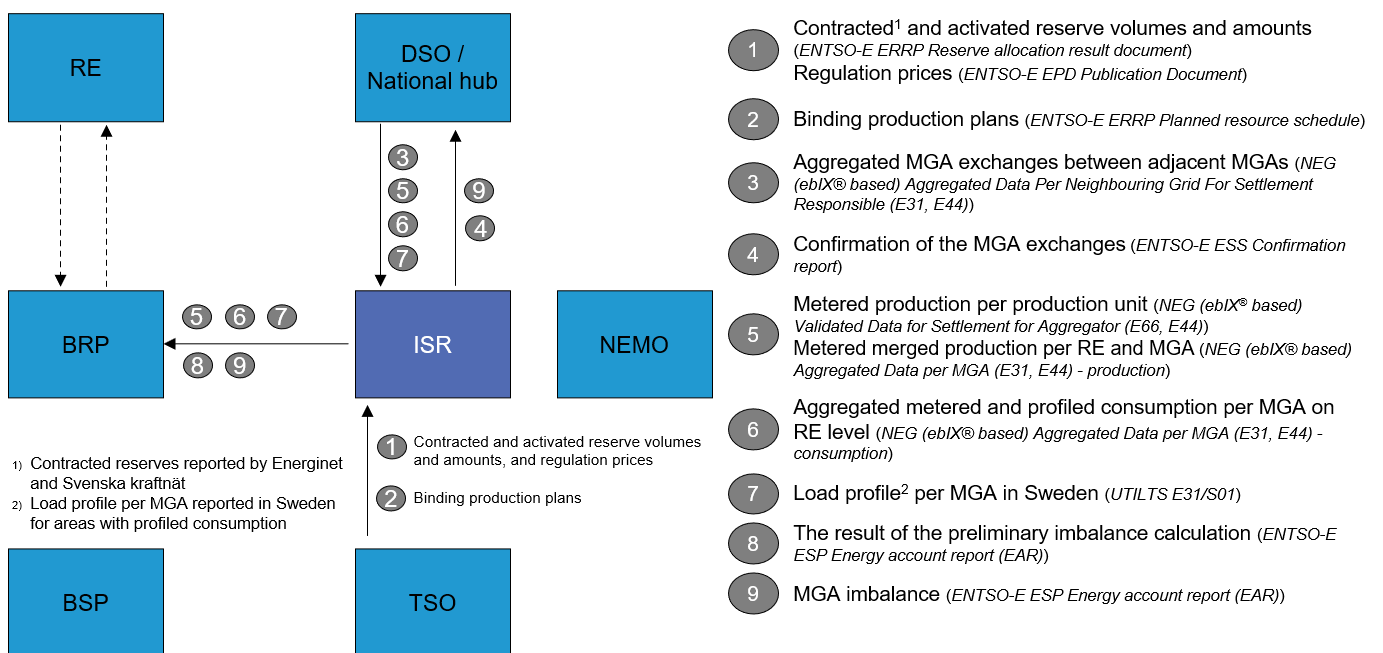

Figure 11. Reporting after the delivery (1-13 days).

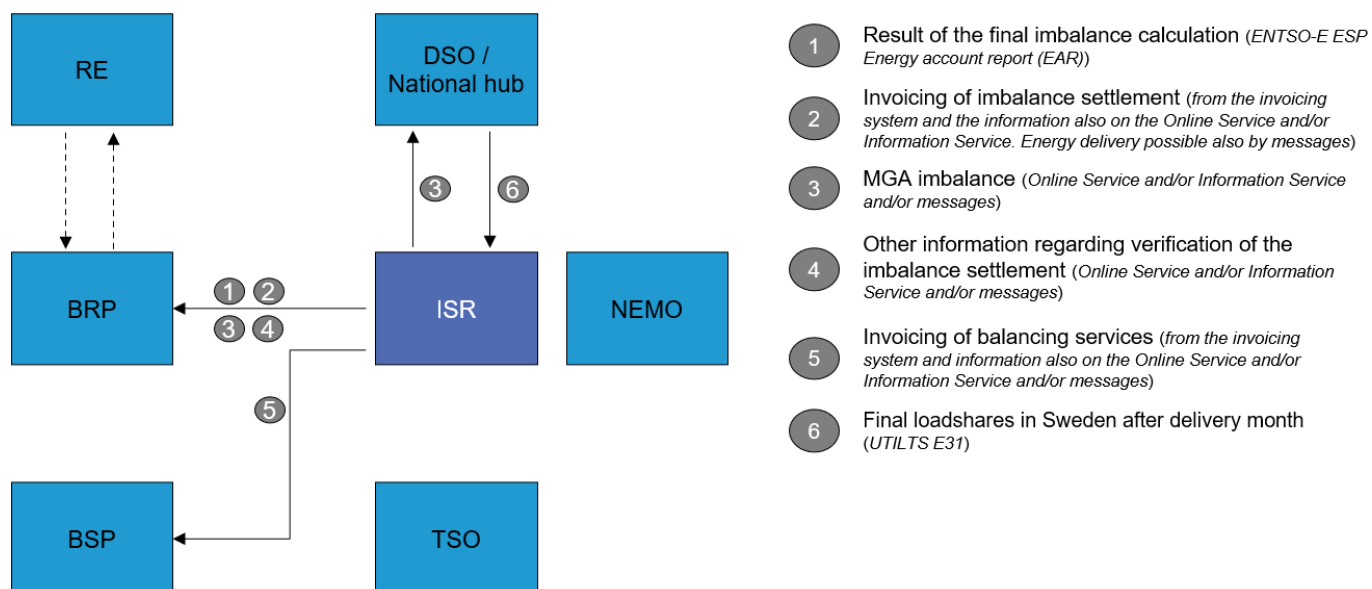

Figure 12. Reporting after the imbalance settlement has been closed (13 days).

Table 8 below shows how eSett reports information to the market participants and the communication channels.

the next working day after the final reporting day, eSett will perform and publish the final result of imbalance settlement in the Online Service and in the Information Service.

In Norway, Norwegian DSOs report all their measurements to Elhub. They will then report all aggregated time series to eSett.

Based on Finnish legislation, the DSOs in Finland are able to report delivery day settlement data in EET/EEST until 00:00 EE(S)T on the 12th day after the delivery day.

Due to Swedish secondary legislation the DSOs in Sweden are able to report delivery day settlement data until the 13th day at 00:00 SNT after the delivery day.

In Denmark, Danish DSOs will report all their measurements to Energinet DataHub. They will then report all aggregated time series to eSett.

An illustrative picture of the settlement data reporting schedule for one delivery day is presented in Figure 13. In the figure, metered data for the Sunday in week 1 shall be reported at the latest on the second day after the delivery day, i.e. on Tuesday in week 2. Updates must be reported at the latest 13 days after the delivery day, i.e. on the Saturday in week 3 in the illustration below. The data may be reported daily for each day or just the changed values. By the end of Sunday in week 2, the data for Monday in week 1 is considered as final and may not be reported on Monday in week 3. By the end of the day on Saturday in week 3, all metered data for the whole week 1 is considered to be final, and final settlement is performed. Invoicing for week 1 is carried out on the first working day after the final reporting day (see more information about invoicing in Chapter 8, Invoicing).

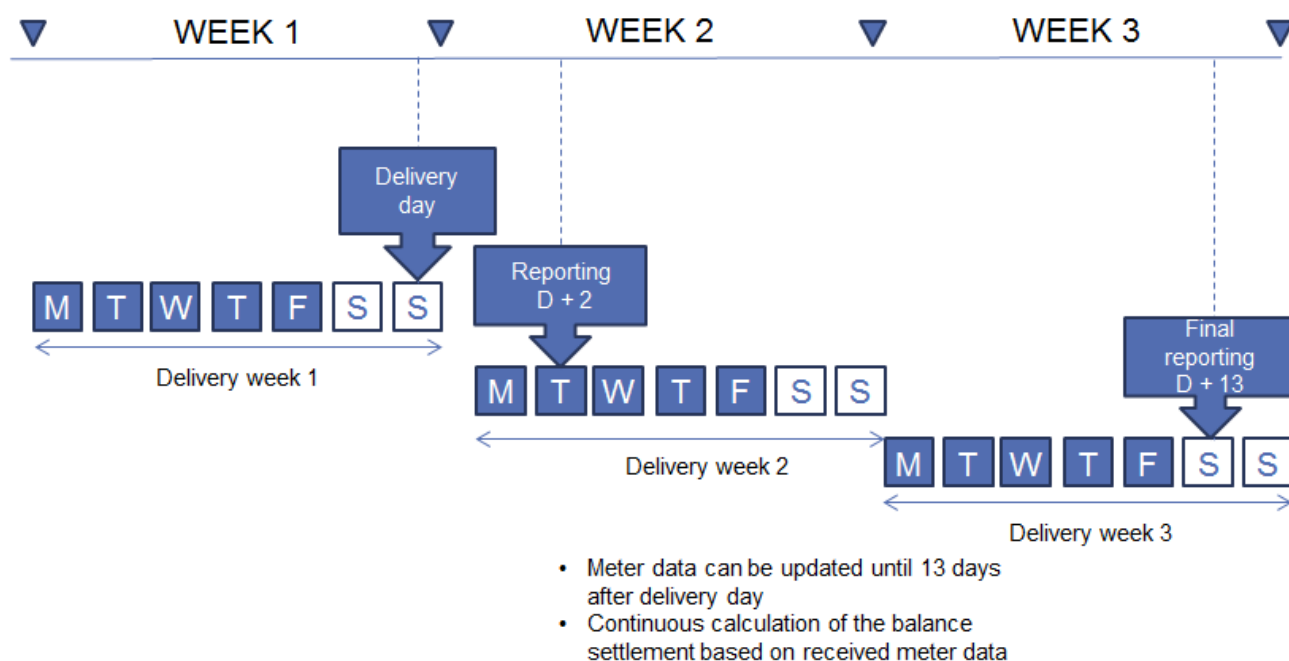

Figure 13. Time schedule for reporting imbalance settlement data.

5.4 Reporting Responsibility

The reporting roles and responsibilities per each Market Participant are presented in the chapters below. Data reporting tasks have been divided by the market role and the time when the data reporting takes place. In the last column of the tables the counterpart in each action is marked.

5.4.1 BRP

5.4.1.1 Bilateral Trade Reporting

All bilateral trades shall be reported before gate closure (each ISP has its own gate closure). A bilateral trade shall be reported on a RE level. In the Nordic Imbalance Settlement Model eSett will aggregate data on BRP level. BRPs are responsible for reporting bilateral trades performed by REs that the BRP is responsible for. Bilateral trade values are verified by eSett's imbalance settlement system.

The reported values by the two counterparts must match; if the values do not match the imbalance settlement system corrects the values according to pre-defined correction rules and sends notification to both parties involved. The BRPs can then take action as described in the procedure below. It is possible that only one BRP submits the bilateral trade, the correction rules (matching) will then be applied.

The correction rules are the following (in case of values not matching):

- If both BRPs report a sale, zero will be used
- If both BRPs report a purchase, zero will be used
- If one BRP reports sale and the other reports purchase, the lowest absolute value per ISP will be used (zero is considered as a number)
- If only one of the BRPs have reported values, those values will be used

1st gate closure for bilateral trade is 45 minutes before the ISP in NO and SE while in DK it is 20 minutes and in FI it is 0 minutes before the ISP. Matching will be performed every time a bilateral trade is received from the BRPs. When the matching is done, an Intermediate Confirmation Report (iCNF) will be sent to both BRPs by file.

The iCNF will include the matched value and the difference between the reported values (delta). The delta is calculated as:

$$\Delta = VALUE_{BRP\ SALE} - VALUE_{BRP\ PURCHASE}$$

2nd gate closure for bilateral trade is at 24:00 next working day after the delivery day. The matching process will, between the 1st and 2nd gate closure, be as follows:

- ISPs where there is a match:
 - The involved BRPs shall immediately after the 1st gate closure receive a final confirmation report (fCNF) for those ISPs where there is a match.
- ISPs where match is achieved by acceptance of the counterpart's values:
 - The BRPs have the possibility to manually accept to use the counterparts' values for ISPs where there is no match on the Online Service. The BRP may do this ISP by ISP or for a longer time period in the same operation.
 - Both BRPs have equal rights to accept to use the counterparts' values. This is based on the "first come first serve" principle. The values can only be corrected once between 1st and 2nd gate closure.
 - For ISPs where one of the BRPs has chosen to accept the counterpart's values, a fCNF will be sent short time after acceptance.
- After the 2nd gate closure (24:00 next working day after the delivery day):
 - fCNF will be sent for the bilateral trades of the previous day.

5.4.1.2 Reporting Schedule BRP

BRP's Responsibilities				Counterpart
Responsibility	Before gate closure	Short time after gate closure	Delivery day + 1 at 24:00 CET	
Report bilateral trade	1			eSett
Accept the counterparty's values for bilateral trade			2	BRP

Table 9. BRP's responsibilities.

Before delivery:

1. Report bilateral trades
 - 0 minutes before ISP in Finland
 - 20 minutes before ISP in Denmark
 - 45 minutes before ISP in Sweden and Norway.

After gate closure:

2. The party may accept the counterparty's values the next working day after delivery day before 24:00 CE(S)T.

5.4.2 DSO

5.4.2.1 MGA Exchange Reporting

The DSOs are responsible for reporting MGA exchanges. Both DSOs are expected to report the MGA exchange, but the correction rules take into consideration that only one DSO might report. The imbalance settlement IT system verifies the reported MGA exchanges and checks if the values match between the two counterparties. If the values do not match, the values are changed according to pre-defined correction rules. After this the imbalance settlement IT system sends a notification to the counterparties. The notification is sent to the DSOs and will also be visible on the Online Service. The notification contains information about the new corrected value.

Correction rules for MGA exchanges:

- If both DSOs report export, zero will be used.
- If both DSOs report import, zero will be used.
- If one DSO reports export and the other reports import, the lowest absolute value per ISP will be used (zero is considered as a number).
- If only one of the DSOs have reported values, these values will be used.

The DSO verifies the corrected MGA exchanges values. If the time period is still open, the DSO can initiate the sending of new values either via the Online Service or in an electronically sent message. If the time period is closed, the DSO can only view what the corrected value was set to.

The matching process will be, during the period between the 2nd day after the delivery day and 13 days after delivery day, as follows:

- 2nd day after the delivery day
 - Matching will be performed every time MGA-MGA exchanges is received.

- An iCNF (intermediate confirmation report) will be sent to both DSOs. The iCNF will include the delta and the matched value.
- 13 days after delivery day
 - fCNF (final confirmation report) will be sent for all ISPs of the relevant period.

If the two MGAs of an MGA exchange are located in different countries with different reporting schedules, the stricter reporting schedule is applied for both DSOs for reporting values to the MGA exchange.

5.4.2.2 Example of MGA Exchange Reporting

Figure 14 below illustrates how the DSO will aggregate the MGA exchange when reporting. The sum of the exchange measurements (1-5) will be reported to eSett.

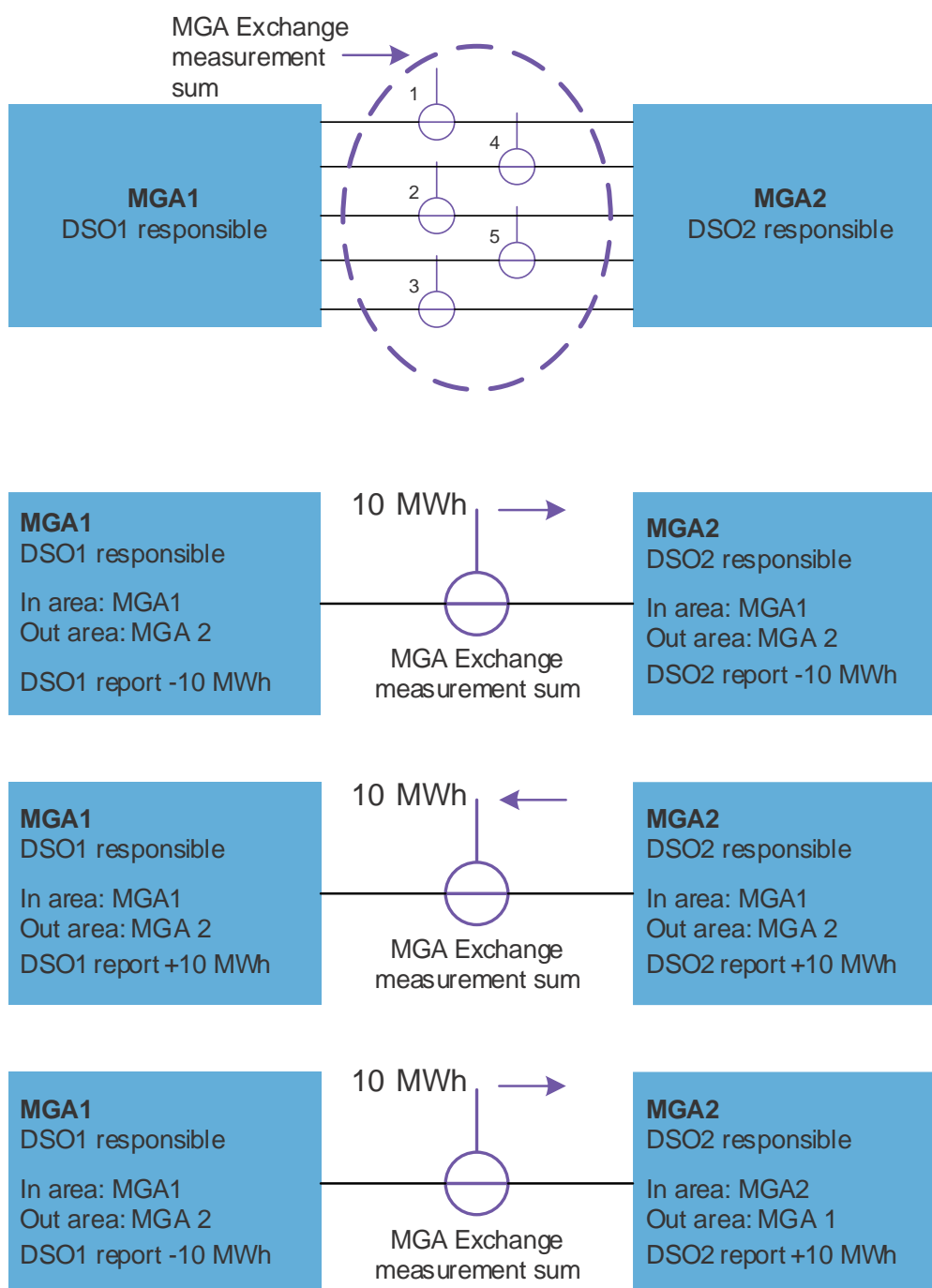

Figure 14. Example of MGA exchange reporting.

5.4.2.3 Reporting of Production

The DSO will be responsible for reporting metered data per production unit to eSett, which will then aggregate metered data on BRP level per MGA and per type. In some countries there is also a possibility to report metered merged production data per RE, MGA and type, which will then aggregate to metered data on BRP level per MGA and per type.

The production unit types can be for example: hydro, wind, nuclear, solar and thermal.

In Sweden production with installed capacity < 1 MW should be reported as merged production per RE, production unit type and MGA with production type minor.

In Finland, minor production (< 1 MW) should be merged to one PU per RE, production unit type and MGA with production type minor. That is, when the minor production exceeds retailers aggregated consumption. This production will then also be reported per production unit with the production type minor.

In Denmark, all production will be reported by the national electricity market hub as merged production per RE and MGA with production unit type other and production type normal.

5.4.2.4 Reporting of Consumption

The DSO will be responsible for reporting metered data to eSett. The DSO will report aggregated metered values per RE and MGA.

The aggregated consumption will be reported on the following types per country:

Sweden:

- Metered consumption
- Preliminary profiled consumption (i.e. consumption that is metered on a monthly basis)
- Metered interruptible consumption
 - Interruptible consumption means objects that can be controlled and switched off completely, which for example electric boilers, heat pumps or the equivalent (the requirement is that it is hourly metered)
 - Disconnecting them can adjust consumption to the current market situation (influenced by the price of electricity) or reduce power to the electrical system
- Metered industry consumption over 50 MW
 - Industry consumption over 50 MW is reported as an own RO in Sweden, implying that consumption plans are reported per RO
- Profiled and metered losses
 - Losses per MGA are calculated based on the MGA exchange, metered production and metered consumption as follows:
 - Profiled losses = - (MGA exchange + metered production + metered consumption + preliminary profiled consumption)
 - Metered losses: - (MGA exchange + metered production + metered consumption)

Norway:

- Metered consumption
- Preliminary profiled consumption (i.e. consumption that is metered on a monthly basis)
- Profiled and metered pumped

- The profiled and metered pumped consumption are used for pumps that are used to pump water from one waterway to another so that it can be utilized in the production units.
- The profiled and metered pumped consumption will be deducted from the production before these guarantees of origin are issued.
- Metered pumped storage
 - Norway has a significant installed capacity of combined pump and generation units; production units that can reverse the turbine so that it acts like a pump. These units represent added flexibility for upward and downward regulations compared to normal production units. In order to ensure an efficient handling of this flexibility the BRP will place a single bid for reserves to the TSO including both production and consumption. Up regulation can be delivered as reduction of pumping, increased production or a combination of the two.
- Losses
 - Losses per MGA are calculated according to existing Elhub Edielstandard.

Finland:

- Metered consumption
- Preliminary profiled consumption (i.e. consumption that is metered on a monthly basis)
- Losses
 - Losses per MGA are calculated based on the MGA exchange, metered production and metered consumption as follows:
 - Losses = - (MGA exchange + metered production + metered consumption + preliminary profiled consumption)

Denmark:

- Metered consumption
- Flex-settled consumption
 - Flex-settlement is used for metering points with an annual consumption of less than 100,000 kWh, where the grid operator continuously remote-reads and distributes values, and where these values are used for imbalance settlement.

5.4.2.5 Reporting of Loadshares in Sweden

The DSO will be responsible for reporting of load profile shares per BRP per MGA per month to eSett. This applies for DSOs in Sweden that have profiled consumption in their MGAs. Preliminary load profile shares are used for the calculation of profiled consumption volumes per BRP and MGA in Sweden. Final load profile shares are used for the reconciliation settlement.

The load profile shares will be reported on the following types:

- Preliminary – general
- Preliminary – losses
- Final – general
- Final – losses

Preliminary load profile shares are reported before the delivery month. Final load profile shares are reported after the delivery month once the meter readings for the delivery month are available.

5.4.2.6 Reporting of Load Profiles in Sweden

The DSO will be responsible for reporting of load profiles per MGA per ISP to eSett. This applies for DSOs in Sweden that have profiled consumption in their MGAs. Load profiles are used for the calculation of profiled consumption volumes per BRP and MGA in Sweden, as well as for the reconciliation settlement.

5.4.2.7 Reporting Schedule DSO

DSO's Responsibilities					Counterpart
Responsibility	Before delivery	Delivery day + 2	Delivery day + 13 at 12:00 CET	2 months after delivery month	
Report metered data per production unit		2			eSett
Report updated metered data per production unit			4		
Report aggregated metered data		3			
Report updated aggregated metered data			4		
Report metered data per consumption metering point		2			RE
Report updated metered data per consumption metering point			4		
Report preliminary loadshares per BRP, MGA and month in Sweden	1				eSett
Report load profiles per MGA in Sweden		2			
Report updated load profiles per MGA in Sweden			4		
Report final loadshares per BRP, MGA and month in Sweden				5	

Table 10. DSO's responsibilities.

Before the delivery month:

1. Report preliminary load profile shares before delivery month:
 - Only for MGAs with BRP level profiled consumption in Sweden
 - Loadshare data per BRP per MGA per month separated for types general and losses

2-13 days after the delivery day:

2. Report metered data before 10:00 CE(S)T the second day after delivery day:
 - Metered data on production reported to eSett and RE per production unit
 - Metered data per consumption metering point reported to RE
 - Load profile data per MGA reported to eSett and BRPs
3. Report aggregated metered data before 10:00 CE(S)T on the second day after delivery day. Metered data should be available at eSett's database for BRP and RE as an aggregated volume per RE. Missing daily

collected metered data in a single metering point must be estimated, according to national practice / regulations by the DSO before aggregation.

- Per MGA aggregated metered data from exchange metering points to eSett
 - Per MGA aggregated metered consumption data per RE to eSett
 - Per MGA aggregated preliminary profiled consumption per RE to eSett
 - Per MGA aggregated merged production data per RE to eSett
4. Report updated metered data before 12:00 CE(S)T the 13th day after delivery day.
 5. Report final load profile shares before the end of second month after delivery month:
 - Only for MGAs with profiled consumption in Sweden
 - Loadshare data per BRP per MGA per month separated for types general and losses

5.4.3 eSett

eSett performs preliminary and a final settlement and reports/publishes the results after each settlement. The result after the preliminary settlement will be reported the 2nd day after delivery day. eSett performs regularly preliminary settlement calculations and publish the results on the Online service. The result of the final settlement will be reported the 1st working day after DSOs final reporting day (D+13).

The details regarding eSett's reporting and publishing of the settlement data includes for example information listed in sections below. The data may be available as a data flow after subscription, on the Online Service or both.

Details of data that eSett provides as a data flow regarding Swedish profiling and reconciliation is listed in **Table 28** UTILTS Data Packages for Swedish profiling and reconciliation. Further details of eSett publishing data can be found from Appendix 3.

5.4.3.1 eSett Reporting or Publishing to BRP

- Aggregated production plan per BRP and MBA
- Aggregated production plan per BRP and RO
- Aggregated normal production per BRP and MBA
- Aggregated minor production per BRP and MBA
- Aggregated consumption per BRP and MBA
- Aggregated consumption per type per BRP and MBA
- Aggregated consumption per RE and MGA
- Aggregated pump storage consumption per BRP and MBA
- Calculated MGA imbalance per BRP and MGA
- Aggregated MGA trade import and export per BRP and MBA
- Aggregated MGA imbalances (surplus and deficit) per BRP and MBA
- Aggregated day-ahead trades (purchase and sales) per BRP and MBA
- Aggregated intraday trades (purchase and sales) per BRP and MBA
- Aggregated bilateral trades (purchase and sales) per BRP and MBA
- Imbalance purchase and sales (volumes and amounts) per BRP and MBA
- Production and consumption Imbalance Adjustments up and down per BRP and MBA

- Relative imbalance per BRP and MBA
- Imbalance and regulation prices per MBA

5.4.3.2 eSett Reporting or Publishing to BSP

- Activated reserves per type per BSP and MBA
- Contracted reserves per type per BSP and MBA
- Imbalance and regulation prices per MBA

5.4.3.3 eSett Reporting or Publishing to DSO

- Aggregated metered production per MGA
- Aggregated metered consumption per MGA
- MGA imbalances
- MGA exchanges

5.4.3.4 eSett Publishing of Information Regarding RE

- Aggregated metered production per RE and MBA
- Aggregated metered consumption per RE and MBA
- Aggregated bilateral trades per RE and MBA
- MGA exchange trade per RE and MGA

5.4.3.5 Reporting Schedule eSett

eSett's Responsibilities				Counterpart
Responsibility	Before delivery	2 - 13 days after delivery	After final imbalance settlement	
Provide aggregated data		1		BRP
Provide final aggregated data			4	
Report preliminary imbalance settlement results		3		
Report final imbalance settlement results			6	
Send invoice			7	
Provide aggregated data		1		BSP
Provide final aggregated data			4	
Send invoice			7	
Provide aggregated data		1		RE
Provide final aggregated data			4	
Provide aggregated data		1		DSO
Provide final aggregated data			4	
Report preliminary quality assurance		2		
Report final quality assurance			5	

Table 11. eSett's responsibilities.

2-13 days after delivery:

1. Provide aggregated data to BRP, BSP, RE and DSO
2. Report preliminary quality assurance (MGA imbalance) on area balance per MGA to DSO
3. Report preliminary imbalance settlement results

After final imbalance settlement:

4. Provide final aggregated data to BRP, BSP, RE and DSO
5. Report final quality assurance (MGA imbalance) on area balance per MGA to DSO
6. Report final imbalance settlement results
7. Send invoice for one delivery week electronically to the BRP and BSP on the next working day after the final reporting day of the week

5.4.4 NEMO

5.4.4.1 Reporting of PX Market Trades, PX Market Flows and Bilateral Trades

NEMO will report the Day-ahead and Intraday trades to its customers and eSett. Day-ahead and Intraday Auction trades will be reported when NEMO has completed the price calculation and continuous Intraday trades will be reported continuously. The Day-ahead and Intraday trades will be reported per RE and per MBA.

NEMO will report Day-ahead and Intraday flows between respective MBAs to eSett and TSOs.

NEMO will report Bilateral Trades between NEMOs per MBA to eSett.

Final values of PX market trades, PX market flows and Bilateral trades to be reported to eSett latest D+13 12:00 CE(S)T after the delivery day and to TSOs according to the agreements between NEMO and TSOs.

5.4.4.2 Reporting of Prices

The day-ahead market price is calculated by algorithm called EUPHEMIA (acronym of Pan-European Hybrid Electricity Market Integration Algorithm) that calculates day-ahead electricity prices across Europe, and allocates cross border transmission capacity on a day-ahead basis. The day-ahead market price is based on the sale and purchase orders from market participants in all available day-ahead markets. The day-ahead market price is used as a reference price for trading and clearing of most financial contracts in the Nordic countries.

The Day-ahead market is divided into several market balancing areas and the available transmission capacity may vary and congest the flow of electrical energy between the areas. Hence, different area prices are established.

Area prices are calculated and published by the NEMOs, which are then reported to eSett.

5.4.4.3 Reporting Schedule NEMO

NEMO's Responsibilities				Counterpart
Responsibility	Before delivery	Delivery day + 2	Delivery day + 13 at 12:00 CET	
Report day-ahead and intraday trades	1			eSett
Report final day-ahead and intraday trades			2	
Report bilateral trades	1			
Report final bilateral trades			2	
Report day-ahead and intraday flows	1			
Report final day-ahead and intraday flows			2	
Report day-ahead prices	1			
Report final day-ahead prices			2	

Table 12. NEMO's responsibilities.

Before delivery:

1. Report all Day-ahead trades, flows, Bilateral trades and Day-ahead prices made for the next day to eSett and market participants active in PX market. Report all Intraday trades, flows and Bilateral trades before the delivery to eSett and market participants active in PX market.

2-13 days after the delivery day:

2. Report delivery day final Day-ahead trades, flows, Bilateral trades and Day-ahead prices to eSett and market participants active in PX market latest D+13 12:00 CE(S)T. Report delivery day final Intraday trades, flows and Bilateral trades to eSett and market participants active in PX market latest D+13 12:00 CE(S)T.

5.4.5 TSO

5.4.5.1 Reporting of Balancing Services

The BSP shall place bids in the Balancing Markets operated by the TSO. The TSO will report the services provided by the BSP to eSett. The TSO reports the activated reserves per RO and balancing sub service, volumes and amounts. Energinet and Svenska kraftnät report also the contracted reserve volumes and amounts per balancing sub service. Reporting is carried out the day after delivery and there are national differences regarding balancing service sub types which will be applied. eSett aggregates the reported activated reserves to imbalance adjustments.

5.4.5.2 Reporting of Regulation Prices

The regulation prices are calculated in the NOIS system and reported by the TSOs to eSett continuously as they become official.

5.4.5.3 Reporting of Production Plans

The TSO reports the binding production plans to eSett based on the BRPs reporting. The binding production plans are per BRP and RO. In Denmark, production plan values are not reported to eSett.

5.4.5.4 Reporting Schedule TSO

TSO's Responsibilities				Counterpart
Responsibility	Before delivery	Short time after delivery	Delivery day + 13 at 12:00 CET	
Report all balancing reserves		1		BSP
Report all contracted reserves		1		eSett
Report all activated reserves		1		
Report binding production plans		2		

Table 13. TSO's responsibilities.

Before delivery:

Check consistency of the data reported by BRP and BSP and request correction if needed.

Short time after delivery:

1. All activated reserves, contracted reserves and any other agreed BSP-TSO trades during delivery day are reported to BSP and eSett.
2. Report binding production plans to eSett

5.4.5.5 Reporting of Binding NEMOs Day-ahead and Intraday Flows

In Sweden, Svenska kraftnät shall report the binding TSO-TSO matched NEMOs Intraday flows to eSett based on the NEMOs reporting. eSett shall receive the binding NEMOs Day-ahead flows as part of the daily single day-ahead coupling operations.

5.5 Validation of Reported Data

The data is reported electronically via market messages from the market participant's IT system to eSett's imbalance settlement system or entered in the Online Service. In abnormal situations, the data can be reported by e-mail or phone directly to eSett's personnel. Before aggregation, the syntax and content of the incoming data are validated by eSett's imbalance settlement system in order to ensure that the data can be used in the settlement calculations. The reporting parties are informed about the validation result (e.g. via acknowledgement messages). After validation, the data is stored in eSett's imbalance settlement system and the imbalance settlement calculations are performed.

Both the data sent by market participants and the final calculated settlement data are published in the Online Service so that they can be verified, and possible errors can be reported to eSett. In addition, the market participants are given the opportunity to utilise the Information Service, which provides the market participants with the settlement data (as time series data) that they are entitled to see. The Information Service (presented in Chapter 10.3 Information Service) is established as a machine-to-machine interface and made available to market participants authorised by eSett.

The market participants themselves are responsible for the accuracy and quality of the reported data. eSett sends and publishes the data received from the parties and is not able to verify the correctness of the received data.

5.6 Reporting in Disturbance Situations

A disturbance in the market participant's solution does not discharge the market participant from the liability to report the settlement data to eSett. If the market participant is unable to report the settlement data electronically due to a disturbance in the market participant's solutions, the settlement data shall be reported via the Online Service.

If the reporting cannot be performed due to a disturbance in eSett's IT solution, the messages will be received in the same order as they have been sent to eSett once the disturbance is over.

6 Imbalance Settlement

This chapter contains an overview of the imbalance settlement including a calculation example. Also applied, national, reconciliation settlement models are presented.

In the Nordic Imbalance Settlement Model, the settlement of BRPs' imbalances is based on the harmonised Nordic model which was implemented in all Nordic countries 2009 and updated in 2021. The updated model is based on single imbalance calculated and settled.

Imbalance volume is calculated as the deviation between consumption, metered production, trades, MGA imbalance and imbalance adjustment. The applied pricing model is described in detail in chapter 7 Pricing and Fees.

eSett will conduct a preliminary imbalance settlement every day starting from the second day after the delivery day until the final settlement 13 days after delivery.

Imbalance volumes are calculated as follows:

$$\text{Production} - \text{Consumption} + \text{Trade} + \text{Imbalance adjustment} + \text{MGA imbalance} = \text{Imbalance volume}$$

The BRPs and the DSOs are responsible for resolving possible errors with the counterpart within the reporting window. The DSO has at most 13 days to correct and resubmit erroneous data before eSett invoices the imbalance energy. The reporting responsibilities and schedule are presented in chapter 5 Settlement Data Reporting. No corrections of the imbalance settlement will be made by eSett after the invoice has been created and submitted.

6.1 Imbalance Settlement Calculation

The imbalance volumes are calculated based on received settlement data. The calculation is performed per MBA at BRP level and includes data from the parties in the BRP's balance hierarchy, using relations in the structure information (e.g. BRP's responsibility over REs).

The imbalance is composed of a BRP's trades, consumption, production, MGA imbalance and imbalance adjustment up and down. For example, a balance deviation in the imbalance arises when there is a difference between the consumption, production and electricity purchases and sales. If the BRP consumes and sells more electricity than it produced and purchased, there is a deficit in the imbalance, and the BRP is required to purchase the imbalance energy from eSett in order to cover the deficit.

Correspondingly, if the BRP produces and purchases more electricity than it consumed and sold, there is a surplus in the imbalance, and the balance responsible party sells imbalance energy to eSett in order to take care of the surplus.

Imbalance is calculated from the input data in the imbalance settlement system delivered by market participants. This data contains metered and profiled consumption per RE per MGA, metered production per production unit, MGA exchange per MGA per adjacent MGA, day-ahead and intraday trades per RE per MBA, bilateral trades per counterpart per MBA and imbalance adjustments (sum of Frequency Containment Reserves (FCR), Frequency Restoration Reserves (FRR) and Replacement Reserves (RR)).

Based on the delivered data the metered and profiled consumption per BRP in MBA, metered production per BRP in MBA, MGA imbalance per BRP in MBA, MGA exchange trade per BRP in MBA, day-ahead, intraday, and

bilateral trades per BRP in MBA and imbalance adjustment up and down per BRP in MBA are calculated by eSett. Altogether the result is imbalance per BRP in MBA. Calculation of the imbalance is shown in **Figure 15**.

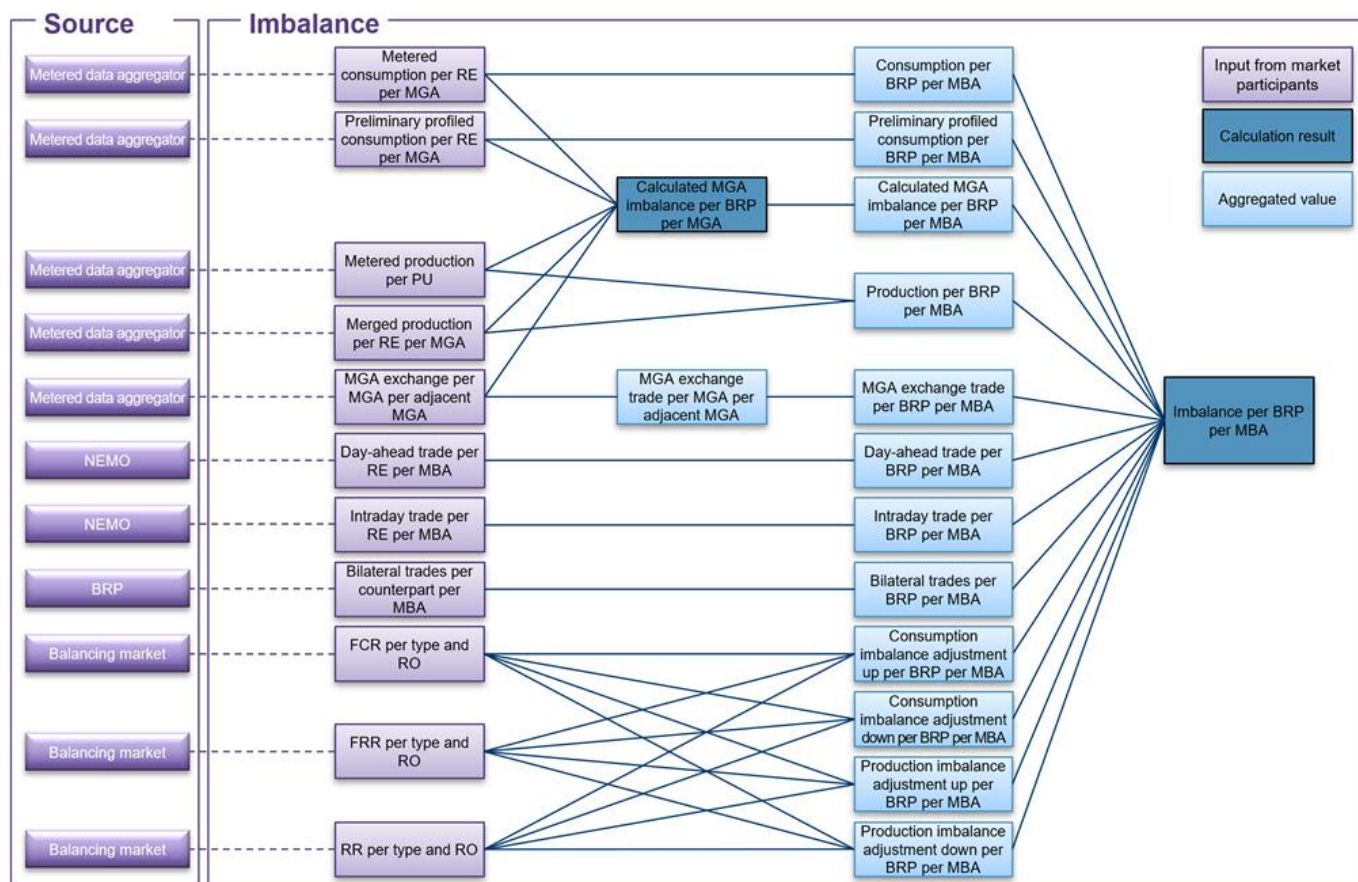

Figure 15. Calculation of imbalance settlement.

6.1.1 National Differences in Settlement

In Sweden the preliminary profiled consumption is calculated by eSett per BRP in MGA instead of retailer in MGA. DSOs are responsible for reporting loadshares and load profile if they have profiled consumption in Sweden.

6.1.2 MGA Imbalance

eSett calculates the MGA imbalance based on reported values from the Metered Data Aggregator. MGA Imbalance will be an input to the consumption imbalance calculation and calculated as follows:

MGA Imbalance = Consumption + Production + MGA exchange import per adjacent MGA + MGA exchange export per adjacent MGA

6.2 Example: Calculation of Imbalance Volumes

In this chapter an example of the BRP's imbalance calculation is presented. The example is made from the BRP's perspective (see **Table 14** and **Table 15**).

Imbalance	MWh
Metered consumption	-50
Profiled consumption	-15
Metered production	55
Bilateral trades (purchase)	65
Day-ahead trades (sale)	-40
Intraday trades (purchase)	5
MGA imbalance	5
Imbalance adjustments (up)	-15

Table 14. Imbalance example values.

Imbalance calculation						
Imbalance calculation	Metered + Profiled consumption [MWh]	Metered production [MWh]	Bilateral + Day-ahead + Intraday trades [MWh]	MGA Imbalance [MWh]	Imbalance adjustments [MWh]	Imbalance [MWh]
Imbalance settlement period	-65	55	30	5	-15	10

Table 15. Imbalance calculation.

As a result of the BRP's imbalance calculation $(-65 + 55 + 30 + 5 + (-15))$ there is a 10 MWh surplus in the BRP's imbalance. The BRP sells 10 MWh from eSett.

6.3 Imbalance Settlement with Missing Data

The calculation of imbalances is performed in eSett's imbalance settlement system whether or not all the settlement data has been received. For MECs from which data hasn't been received the value 0 is used in the preliminary calculations but empty settlement data is not changed from void to 0 in the database.

If the values have not been received by gate closure the final calculations are performed with the value 0. The market participant may view the status of reporting in Online Service to view if the calculation was done without having all settlement data available. The statistics include information on what settlement data was missing.

6.4 Management of Imbalance Errors after Gate Closure

There will be no corrections of the imbalance settlement made by eSett after the invoice of a settlement period has been created and submitted. An exception is if eSett has committed errors or due to extraordinary circumstances (force majeure or similar). Handling of imbalance errors after invoicing is done bilaterally between the contracting parties.

Subsequent bilateral correction of imbalance settlement is outside of eSett's scope. Handling of bilateral corrections of imbalance settlement will be performed according to national rules.

6.5 Imbalance Settlement in Disturbance Situations

If the imbalance settlement can't be performed due to eSett according to the schedules, the imbalance settlement will be performed and finalised as soon as the disturbance situation has been resolved.

6.6 Reconciliation

Reconciliation is done according to current national practices. Therefore, the step-wise-approach is used for reconciliation in the Nordic Imbalance Settlement Model. This means that reconciliation is done differently in each of the countries and current national procedures are followed.

In the imbalance settlement, estimates for the profiled consumption are used when meter readings are not available in due time (13 days after delivery day). When the metering data becomes available a new and improved estimate is done and called the final profiled consumption (FPC). In the reconciliation settlement, the difference between FPC and PPC is settled using day-ahead market prices for the MBA. In this way, the error in the imbalance settlement due to incorrect estimates of the profiled consumption is corrected.

Reconciliation frequency and schedule depend on the national schedule explained in the following sub chapters that present the national stepwise approaches. Reconciliation is done if one of the following changes in the settlement structure is done: change of supplier, customer relocation, metering point switches between the profiled and non-profiled consumption or in case of change of meters.

6.6.1 Stepwise Approach in Sweden

In Sweden, eSett is responsible for calculating and reporting reconciled energy on the Swedish market. Reconciliation is settled on BRP level in Sweden. eSett will be responsible for the settlement of the reconciled energy and the invoicing. Content of the description can be found in chapter 8.1 Invoice Contents. Additionally, there is a variation regarding the reporting of profiled consumption compared to the Imbalance Settlement Model in Sweden. The reporting structure in Sweden will be as described below. Metered data for profiled consumption is collected monthly; consumption is aggregated final profiled consumption two months after delivery month for DSO per MGA. eSett calculates reconciled energy per BRP in monthly resolution three months after delivery month.

Profiling

Load Profile Shares are calculated by the DSO before the delivery month. eSett calculates BRPs PPC per MGA. Reporting structure as described below:

- DSO reports Load profile shares per MGA and BRP to eSett and BRP
- DSO reports Load profile per MGA to eSett
- eSett calculates profiled consumption per BRP and MGA
- eSett reports aggregated profiled consumption per BRP and MBA to BRP

Reconciliation

The DSO reports Final Load Profile Shares to eSett. eSett calculates BRPs' reconciled energy and reports it to BRPs. Reporting structure as described below:

- DSO reports final Load Profile Shares per MGA and BRP to eSett
- eSett reports QA data per MGA on reconciled energy to BRP
- eSett publish reconciled energy per MGA and BRP
- eSett report reconciled energy and payment per MBA to BRP
- eSett sends out invoice to BRP

Short description of the model is in Appendix 3. A more detailed explanations can be found from the Svensk Elmarknadshandbok (<https://www.elmarknadshandboken.se/handbok.html>) which is available only in Swedish.

6.6.2 Stepwise Approach in Finland

In Finland reconciliation is managed yearly after final meter reading per metering point. Reconciliation is done between DSO and RE. Profiled consumption has annual meter reading and the DSO is responsible for the meter reading. REs are the financial counterparts for DSOs in the process. Final imbalance profiling is done in an equal way in all meters independent on the meter type. Reconciliation settlement is done on same basis as imbalance settlement and the price is the day-ahead market price of the metering grid area during the imbalance settlement period. Profiled consumption is done annually.

6.6.3 Stepwise Approach in Norway

In Norway reconciliation is handled by the Norwegian datahub, Elhub. eSett is not involved in the reconciliation process.

6.6.4 Stepwise Approach in Denmark

In Denmark there is no reconciliation process since all metering points are metered and settled per imbalance settlement period. Corrections due to changed meter data and settlement structures after gate closure for imbalance settlement is handled by the Danish DataHub in a correction settlement between the affected suppliers.

7 Pricing and Fees

This chapter describes the pricing of imbalances according to the single price model for imbalances. The fees that are charged in the imbalance settlement are also presented in this chapter.

The BRP's imbalance volumes are priced for each imbalance settlement period according to the prices that are generated in the mFRR or aFRR³ energy activation market together with the incentivizing component (IC). The price applied to an ISP of imbalance can be either the up-regulation price or the down-regulation price depending on the dominating direction from the regulation power market. In case there is no activation of balancing energy in either the positive or the negative direction for an MBA for an ISP, a Value of Avoided Activation (VoAA) of balancing energy (mFRR) is used together with the incentivizing component (IC) to determine the imbalance price.

In addition to the pricing of the imbalance volumes, eSett also calculates the fees that are charged from the BRPs in the imbalance settlement. The applicable fee categories are presented in subchapter 7.2.

Prices used in the imbalance calculations
Value of Avoided Activation + Incentivizing Component (EUR/MWh) per MBA
mFRR energy up-regulation price (EUR/MWh) per MBA
mFRR energy down-regulation price (EUR/MWh) per MBA
aFRR energy volume-weighted up-regulation price (EUR/MWh) per MBA
aFRR energy volume-weighted down-regulation price (EUR/MWh) per MBA
Main direction of imbalance adjustment per MBA
Imbalance sales price (EUR/MWh) per MBA
Imbalance purchase price (EUR/MWh) per MBA

Table 16. Pricing information.

7.1 Pricing of Imbalance

Imbalance is priced according to a single price model, which means that positive and negative imbalances have the same price. The price is the mFRR or a volume-weighted aFRR³ energy activation price in the main direction of regulation in the MBA:

- In up-regulation ISPs, the price of negative and positive imbalances is the mFRR energy up-regulation price or if applicable, the volume-weighted aFRR energy up-regulation price.
 - Higher of the two prices is applied.
- In down-regulation ISPs, the price of negative and positive imbalances is the mFRR energy down-regulation price, or if applicable, the volume-weighted aFRR energy down-regulation price.
 - Lower of the two prices is applied.

³ aFRR volume-weighted average price is a valid price component once the respective TSO has joined the European aFRR energy activation market (PICASSO) and can take that price into account in the imbalance price calculation.

- In case there is no activation of balancing energy in either the positive or the negative direction for an MBA for an ISP, a Value of Avoided Activation (VoAA) of balancing energy (mFRR) is used together with the incentivizing component (IC) to determine the imbalance price.
 - The VoAA is computed as the average of the lowest bid for up regulation and the highest bid for down regulation.
 - In case there has been no activation of mFRR, the boundary condition in the Nordic countries shall be that the imbalance price is equal to the day-ahead market price. To make sure that the imbalance price for that MBA for that ISP is always the same as the day-ahead market price, an incentivizing component (IC) is used to “adjust” the VoAA.
 - The imbalance price is therefore computed as the sum of the VoAA and the IC, where the incentivizing component can be both positive and negative:
 Imbalance price = VoAA + IC
 - For example, if the day-ahead market price is 38, and VoAA is 35, the IC will be 3, and thus the “adjusted” VoAA and Imbalance price are 38.

The pricing model for imbalances is summarized in **Table 17**.

Single price model for imbalances			
	Up-regulation ISPs	Down-regulation ISPs	ISPs with no direction
Negative imbalance of BRP (deficit)	Higher up-regulation price (mFRR or volume-weighted aFRR)	Lower down-regulation price (mFRR or volume-weighted aFRR)	VoAA + IC
Positive imbalance of BRP (surplus)	Higher up-regulation price (mFRR or volume-weighted aFRR)	Lower down-regulation price (mFRR or volume-weighted aFRR)	VoAA + IC

Table 17. Pricing model for imbalances.

7.2 Fees in the Imbalance Settlement

Income generated by the Nordic TSOs in the imbalance settlement will cover the national cost base, which encompasses for example costs for operating eSett as well as parts of the costs for reserves.

The fees in the imbalance settlement model are calculated and invoiced separately for each market balance area. The fee categories have been harmonized across the countries but the amounts of fees to be charged will be country specific as the cost bases are national. There are three types of harmonised fee: a volume fee on production and consumption, a fee on all imbalances and a weekly fee. In addition to the harmonised fee structure there is one additional fee related to the financing of the Swedish peak load reserves, which is charged only from the BRPs active in the Swedish MBAs.

The fee levels are set by each TSO in proportion to the national cost base. The fees can be changed with one month’s notice. The goal is to keep the fees fixed for at least one calendar year at the time, if possible. TSOs are responsible for calculating and setting the fees and notifying eSett to reduce or increase the fee levels. All fees are published in the Online Service.

Fee structure in the Imbalance Settlement Model	
Fee	Unit
Weekly fee	EUR/Week
Volume fee	EUR/MWh
Imbalance fee	EUR/MWh

Fee structure in the Imbalance Settlement Model	
Fee	Unit
Peak load reserve fee (in Sweden only)	EUR/MWh

Table 18. Fee structure in the imbalance settlement model.

7.2.1 Volume Fee

The Volume Fee is levied on the BRP's total Consumption and Production according to **Table 19**. The Volume Fee is defined as EUR per MWh of Consumption and Production and calculated for each ISP and MBA.

Volume Fee formation per country			
Country	Consumption	Production	
		Normal	Minor
Denmark	X	X	N/A
Finland	X	X	–
Norway	X	X	X
Sweden	X	X	X

Table 19. Volume Fee formation per country.

7.2.2 Imbalance Fee

The Imbalance Fee is levied on sum of the absolute amounts of the BRP's positive and negative Imbalances. The Imbalance Fee is defined as EUR per MWh of Imbalance and calculated for each ISP and MBA.

Alternatively, each TSO has an option to apply Imbalance Fee on the sum of BRP's positive and negative Imbalances that have been netted within each hour, in which case the Imbalance Fee is defined as EUR per MWh of Imbalance and calculated for each hour and MBA. As a result, there shall be no uncontrollable costs for BRPs due to an intermediate solution, where metering is per 15 minutes, but there are no realistic options for BRPs to balance the quarterly imbalances within an hour.

7.2.3 Weekly Fee

The Weekly Fee is levied for each week and country where the BRPs have been active in the week that the invoice covers. The Weekly Fee is defined as EUR per week and country. The maximum fee for a BRP active in all market balance areas in the Nordics will be four times the weekly fee. (I.e., if the weekly fee is 50 EUR per week and country, the fee for a BRP operating in Denmark, Finland, Norway and Sweden is 200 EUR.)

The BSP's Weekly Fee is levied for each week and country where the BSPs have been active in the week that the invoice covers. The BSP's Weekly Fee is defined as EUR per week and country. The maximum fee for a BSP active in all market balance areas in the Nordics will be four times the BSP's weekly fee. (I.e., if the BSP's weekly fee is 50 EUR per week and country, the fee for a BSP operating in Denmark, Finland, Norway and Sweden is 200 EUR.)

If the company has both BRP and BSP role in the country, then only BRP's Weekly Fee will be charged.

7.2.4 Peak Load Reserve Fee (Sweden)

In addition to the harmonised fee structure there is an additional national fee related to the financing of the Swedish peak load reserves. This fee is levied on BRPs active in the Swedish balancing areas and will be invoiced by eSett

on behalf of Svenska kraftnät. The peak load reserve fee is based on the BRP's metered and profiled consumption, excluding network losses for networks requiring licenses. The fee is charged between 16th of November and 15th of March on working days between 06.00-22.00 CET. If a profit or loss arises at the end of a peak load reserve fee period, it will be included in the next year's calculation of the fee.

7.3 Example: Calculation of Imbalance Amounts

This chapter contains an example of imbalance calculation with prices. The example is based on the ones used to describe the calculation of imbalance volume in chapter 6.2. It presents BRP's imbalance calculation. In the calculation the ISP in question is assumed to be an up-regulation ISP. The example is made from the BRP's perspective. Prices and fees used in the example are defined in **Table 20** below.

Price item or fee	€/MWh
Up-regulation price	40
VoAA + IC	30
Sales and purchase price for imbalance	40
Volume fee	0,50
Imbalance fee	1,50

Table 20. Fees and prices used in the imbalance calculation.

As a result of the BRP's imbalance calculation there is a surplus of 10 MWh. The BRP sells 10 MWh imbalance energy to eSett.

Invoicing is done from the BRP's point of view. The BRP's balance has a 10 MWh surplus. The BRP's balance evens up by the BRP selling imbalance energy to eSett. In the invoicing a negative expense means compensation to the BRP.

The invoicing for the imbalance is the following:

Invoicing information for the BRP's imbalance			
Invoicing information	Volume [MWh]	Price [EUR]	Amount [EUR]
Sale of imbalance energy to eSett	-10	40	-400
Purchase of imbalance energy from eSett	0	40	0
Volume fee	120	0,50	60
Imbalance fee	10	1,50	15
Total purchases from eSett			75
Total sales to eSett			-400
Total invoice amount			-325,00

Table 21. Invoicing information for the BRP's imbalance.

8 Invoicing

This chapter describes the model and procedures for invoicing and payment of the imbalance settlement results and specific balancing services. The handling of value-added taxes and different currencies is also explained.

eSett manages the invoicing and money transfers in the imbalance settlement. The amounts to be settled include the BRPs' imbalances, the fees charged from the BRPs as well as payments for balancing services between the TSO and the BSP. The TSOs are legally responsible for the imbalance settlement, but eSett carries out the settlement and invoicing on their behalf. The imbalance settlement is to a great extent a matter of passing money between BRPs. However, all transfers pass through eSett who guarantees the financial settlement. The net proceeds from the settlement in each country will be transferred to the respective TSO. EUR is the common currency in which all settlement is performed. It is, however, possible for BRPs in Denmark, Norway and Sweden to choose to be invoiced in their local currency.

8.1 Invoice Contents

The invoices from eSett to BRPs contain the volumes (MWh), prices⁴ and payable amounts (EUR or local currency) of the imbalances during the settlement period. The invoices also contain the fees accrued in the settlement period. The content of the invoice is illustrated in **Figure 16**.

Invoice from eSett to BRP	Quantity MWh	Price EUR, SEK, NOK or DKK	Amount EUR, SEK, NOK or DKK
Sales by eSett			
Sold imbalance	xxx	xxx	xxx
Volume Fee	xxx	xxx	xxx
Imbalance Fee	xxx	xxx	xxx
Peak-Load Reserve Fee (applies in Sweden only)	xxx	xxx	xxx
Weekly Fee	xxx	xxx	xxx
Purchases by eSett			
Purchased imbalance	xxx	xxx	xxx
Total sales by eSett (positive amount)			
Total purchases by eSett (negative amount)			
Invoice total (positive or negative amount)			
VAT basis and VAT amounts (Finnish VAT, Norwegian VAT or no VAT)			
Exchange rate used (if any) for converting amounts from EUR to local currency			

Figure 16. Illustrative contents of invoice from eSett to BRPs.

The invoices from eSett to BSPs contain the volumes (MWh or MW for contracted reserves), prices and payable amounts (EUR or local currency) of the bought and sold balancing services during the settlement period. The

⁴ The prices of imbalances and regulation vary for each imbalance settlement period. The prices shown on the invoice are the average prices of each invoice row, which are required due to regulatory requirements on invoices. The prices per ISP can be seen in the Online Service.

invoice can contain a weekly BSP fee if it will be introduced by TSO(s). The content of the invoice is illustrated in **Figure 17**.

Invoice from eSett to BSP			
	Quantity MWh/MW	Price EUR, SEK, NOK or DKK	Amount EUR, SEK, NOK or DKK
Sales by eSett			
Sold activated reserves (divided per type)	xxx	xxx	xxx
BSP Fee	xxx	xxx	xxx
Purchases by eSett			
Purchased activated reserves (divided per type)	xxx	xxx	xxx
Purchased contracted reserves (divided per type)	xxx	xxx	xxx
Total sales by eSett (positive amount)			
Total purchases by eSett (negative amount)			
Invoice total (positive or negative amount)			
VAT basis and VAT amounts (Finnish VAT, Norwegian VAT or no VAT)			
Exchange rate used (if any) for converting amounts from EUR to local currency			

Figure 17. Illustrative contents of invoice from eSett to BSPs.

The invoices from eSett to BRPs which have also a BSP role contain the volumes (MWh or MW for contracted reserves), prices and payable amounts (EUR or local currency) of the bought and sold imbalances and balancing services during the settlement period. The invoice can contain a weekly BSP fee if it will be introduced by TSO(s). The content of the invoice is illustrated in **Figure 18**.

Invoice from eSett to BRP with also BSP role			
	Quantity MWh	Price EUR, SEK, NOK or DKK	Amount EUR, SEK, NOK or DKK
Sales by eSett			
Sold imbalance	xxx	xxx	xxx
Sold activated reserves (divided per type)	xxx	xxx	xxx
Volume Fee	xxx	xxx	xxx
Imbalance Fee	xxx	xxx	xxx
Peak-Load Reserve Fee (applies in Sweden only)	xxx	xxx	xxx
Weekly Fee	xxx	xxx	xxx
Purchases by eSett			
Purchased imbalance	xxx	xxx	xxx
Purchased activated reserves (divided per type)	xxx	xxx	xxx
Purchased contracted reserves (divided per type)	xxx	xxx	xxx
Total sales by eSett (positive amount)			
Total purchases by eSett (negative amount)			
Invoice total (positive or negative amount)			
VAT basis and VAT amounts (Finnish VAT, Norwegian VAT or no VAT)			
Exchange rate used (if any) for converting amounts from EUR to local currency			

Figure 18. Illustrative contents of invoice from eSett to BRPs which have also a BSP role.

Invoice rows representing purchases by the BRP or BSP from the TSO are labelled as “sales by eSett”. The amounts of these rows are positive, i.e. the BRP shall pay these amounts to eSett. Invoice rows representing sales by the BRP or BSP to the TSO are labelled as “purchases by eSett”. The amounts of these rows are negative, i.e. they reduce the amount that the BRP or BSP needs to pay to eSett. The invoice total can be either positive or negative depending on the relative amounts of purchases, sales and fees on the invoice. Invoices with a positive total are labelled “Debit Notice” and settled with a money transfer from the BRP or BSP to eSett. Invoices with a negative total are labelled “Credit Notice” and settled with a money transfer from eSett to the BRP or BSP. When eSett issues Credit Notices to BRPs, this is referred to as “self-billing”.

In addition to the ordinary imbalance settlement invoices, eSett also invoices the BRPs operating in Sweden for the payable amounts arising from the reconciliation of their profiled deliveries. eSett is responsible for the settlement of the reconciled energy and the invoicing process. Invoicing of the reconciled energy is carried out on a monthly basis. The invoice contains the volumes (MWh) and payable amounts of the reconciled energy and profile compensation as well as accrued interest on the payable amounts. The content of this invoice is illustrated in **Figure 19**.

Invoice for reconciled energy from eSett to BRPs in Sweden			
	Quantity MWh	Price EUR or SEK	Amount EUR or SEK
Sales by eSett			
Sold reconciled energy	xxx	xxx	xxx
Purchases by eSett			
Purchased reconciled energy	xxx	xxx	xxx
Interest			xxx
Total sales by eSett (positive amount)			
Total purchases by eSett (negative amount)			
Invoice total (positive or negative amount)			
VAT basis and VAT amounts (Finnish VAT, Norwegian VAT or no VAT)			
Exchange rate used (if any) for converting amounts from EUR to local currency			

Figure 19. Illustrative contents of invoice for reconciled energy of BRPs in Sweden.

8.2 Invoice Distribution

The BRP or BSP receives one invoice for each country where it is active. Companies that operate multiple BRP or BSP roles in a country also get separate invoices for each role.

Companies that operate in the same country with both BRP and BSP roles, shall receive only one BRP invoice. The invoice will contain details from both BRP and BSP invoices as illustrated in **Figure 18**. Companies that operate multiple BRP roles and a BSP role in the same country, shall have the BSP invoice contents in one of the BRP invoices for a designated BRP.

The invoice is distributed as an e-invoice through the network of e-invoice operators active in the Nordic region. eSett’s e-invoice operator is Basware. To receive e-invoices, the BRPs and BSPs need to establish an agreement with an e-invoicing operator and inform eSett of the e-invoicing operator and e-invoicing address that it will use. The e-invoice consists of two components:

- An invoice message in XML, which allows for automatic import of the invoice into the BRP’s or BSP’s accounting system
- A PDF file with a traditional image of the invoice, which facilitates manual review of the invoice

eSett encodes the invoice message in the Finnish Finvoice 3.0 format. However, the BRP or BSP can agree with its invoice operator to receive the invoice in any supported e-invoice format. Any required translation of the message is carried out while the message is transferred from eSett's e-invoice operator to the recipient's e-invoice operator.

BRPs and BSPs that do not wish to receive e-invoices will instead receive their invoices by email in PDF format.

8.3 Debiting and Crediting of Invoice Amounts

eSett will use a direct debiting scheme for collecting the incoming payments from the BRPs and BSPs. This means that when a BRP or BSP receives a Debit Notice from eSett, they should not pay the invoice. Instead eSett will issue an instruction through its main bank to the BRP's or BSP's bank to debit the payable amount from the BRP's or BSP's account and transfer it to eSett. The use of direct debiting helps to ensure timely settlement according to a short settlement cycle. The payments between BRPs and eSett, and BSPs and eSett are all executed as same-day-value payments, which means that the payments will be available to the recipient's bank on the same day as they are paid by the payer. Typically, the funds will also be credited to the recipient's account on that same day, but that depends on the terms agreed upon between the recipient and its bank.

8.4 Required Banking Setup

To participate in the imbalance settlement, the BRPs and BSPs need to hold a bank account(s) in an approved settlement bank, i.e. a bank which has been approved by eSett to be used in the imbalance settlement. This bank account shall enable the direct debiting in the settlement of its outstanding settlement amounts referred to in section 8.3 above. In case direct debiting would not be possible in accordance with the terms and conditions of the said bank account, for example related to anti-money laundering regulations or sanctions, between the Settlement Bank and BRP or BSP, the precondition for the BRP or BSP to be entitled to access the electricity market settlement would not be fulfilled and eSett has the right to terminate the Imbalance Settlement Agreement (BRP) or Balancing Service Settlement Agreement (BSP).

eSett defines the criteria for approval of banks as settlement banks. These criteria include requirements on credit rating as well as the ability to interchange required SWIFT messages with eSett's bank for execution of payments and balance reporting (see chapter 9.9). The settlement bank also needs to sign a Settlement Bank Agreement with eSett.

The list of approved settlement banks is available in the Online Service and in Open Data portal (opendata.esett.com). If a party wishes to use a bank which is not on the list of approved settlement banks, they shall inform eSett and supply the contact details of a contact person at the bank, with whom the necessary process can be initiated to establish the settlement bank status, given that the bank meets the criteria.

Depending on selected settlement bank there are two alternative ways (see list of approved settlement banks in www.esett.com) to setup accounts for the imbalance settlement:

Original model – Pledged Settlement Account Model
Pledged Settlement Account: Pledged Cash Account used for both cash collateral and transactions for invoicing
<i>Invoicing and Cash Collateral</i>
<ul style="list-style-type: none"> • There is only one account, and it is pledged to eSett. • Debit and credit invoice amounts are debited from the Pledged Settlement Account and credited to the Pledged Settlement Account. • Cash collateral is deposited to this account. Any release of funds from the Pledged Settlement Account goes through eSett.
<i>Governance of accounts</i>
<ul style="list-style-type: none"> • The BRP gives eSett access to the account balance with MT940 agreement and right to debit the account with MT101 agreement. • This model requires signing of Agreement on Pledge and Right of Disposal of Cash Account with eSett and BRP's Settlement Bank.

Table 22. *Pledged Settlement Account Model.*

New model – Cash Account Model
Cash Account: Non-pledged cash transaction account used for transactions for invoicing Cash Collateral Account: Pledged account for posting cash collateral
<i>Invoicing</i>
<ul style="list-style-type: none"> • Debit and credit invoice amounts are debited from the Cash Account and credited to the Cash Account. The Cash Account can be a part of BRP's or BSP's cash pool solution or can be account with a credit limit.
<i>Cash Collateral</i>
<ul style="list-style-type: none"> • Collateral is posted to Cash Collateral Account which is pledged to eSett. BRP can only release funds from the account with eSett's approval by requesting collateral release from eSett.
<i>Governance of accounts</i>
<ul style="list-style-type: none"> • The BRP or BSP gives eSett access to the balance of both accounts with MT940 agreement and right to debit the Cash Account with MT101 agreement. • The BRP or BSP has full access to all funds on the Cash Account. Any release of funds from the Cash Collateral Account that is pledged to eSett goes through eSett. • This model requires signing of Agreement on Right of Disposal of Cash Account and Cash Collateral with eSett and customers Settlement Bank.

Table 23. *Cash Account Model.*

The Pledged Settlement Account/Cash Account is used for the debiting and crediting of all payable amounts between the BRP and eSett, and BSP and eSett. In the Pledged Settlement Account Model any collateral that the BRPs and BSPs provide in the form of cash shall also be held on the Pledged settlement account. In the Cash Account model all cash collateral must be held on the Cash Collateral Account. The requirements and procedures related to collaterals are further described in chapter 9.

The currency of the settlement account can be EUR, DKK, NOK or SEK depending on country that the BRP operates (see chapter 8.8 Currency Treatment). The BRPs and BSPs must select the same currency for their pledged settlement account/cash account as they have selected for their invoices. If a party operates in multiple countries, it can have one pledged settlement account/cash account per country over which the invoices for respective country are settled. Or party can have one common account over which invoices are settled if the

invoicing currency is the same in all the countries. The account(s) will be updated by the BRP or BSP through Online Service. Any account setup is subject to review and approval by eSett.

In the **Pledged Settlement Account Model** to enable the debiting of the pledged settlement account and to make it possible to apply the funds on the pledged settlement account as collateral, the BRPs and BSPs need to sign a Pledged Cash Account Agreement, as defined by eSett, whereby they pledge the funds on the account to eSett and grant eSett the necessary right of disposal over the account. The BRPs and BSPs also need to sign MT101 and MT940 agreements with their settlement bank. These agreements are necessary for eSett to direct debit the settlement account and retrieve balance statements of it. An agreement on same-day-value payments to the account is needed if the party wishes to receive the payment as same-day-value payment. The settlement bank will advise on what agreements are required.

In the **Cash Account Model** to enable the debiting the cash account, the BRP or BSP needs to sign an Agreement on Right of Disposal of Cash Account and Cash Collateral, as defined by eSett, whereby they grants eSett the necessary right of disposal over the account. The BRPs and BSPs also needs to sign MT101 and MT940 agreements with their settlement bank. These agreements are necessary for eSett to direct debit the account and retrieve balance statements of the accounts. An agreement on same-day-value payments to the cash account is needed if the party wishes to receive the payment as same-day-value payment. The settlement bank will advise on what agreements are required.

8.5 Invoicing Schedule

Invoicing of the imbalance settlement is carried out on a weekly basis. Invoices are issued each Monday. Each invoice comprises the transactions and fees from the delivery days for which the result of the imbalance settlement has been finalized but not invoiced yet. This means that the invoice on Monday will include the settlement that was finalized during the previous week. This settlement covers the delivery days of the week that started three weeks before the invoicing date. The schedule for settlement and invoicing in relation to the delivery dates is illustrated in **Figure 20**.

Since eSett does not perform imbalance settlement on weekends, the settlement of Sundays' and Mondays' transactions is finalized on a Monday. The transactions from Sundays will be invoiced on the same Monday on which their settlement was finalized. The transactions from Mondays will be invoiced one week after the Monday on which their settlement was finalized.

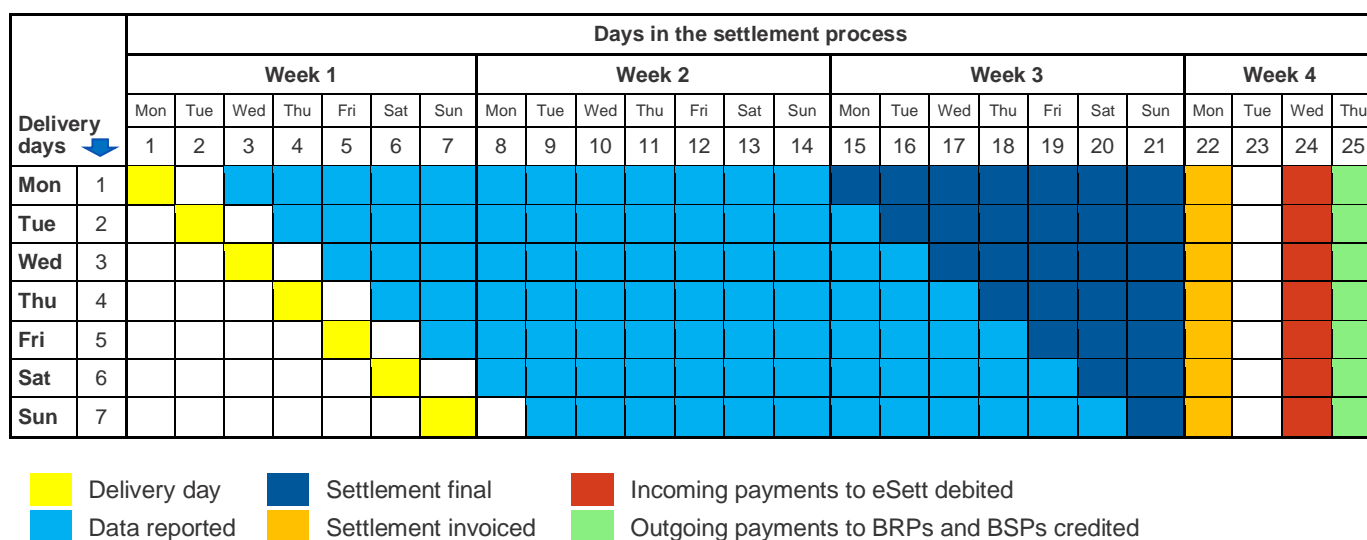

Figure 20. Schedule for settlement, invoicing, and payment.

The payable amounts of the debit notices will be debited by eSett from the settlement account two days after the invoicing day, i.e. on Wednesday. The payable amounts of the credit notices will be paid by eSett to the settlement account three days after invoicing day i.e. on Thursday.

Invoices and updated collateral requirements are published in the Online Service on Mondays by 13 CE(S)T. BRPs and BSPs need to post any required additional collateral during the same day. In addition to the collateral, the BRPs and BSPs also need to have sufficient funds on their accounts for the settlement of their next invoice in case it is a debit notice. These funds also need to be in place during the Monday. The requirements and procedures related to collaterals are further described in chapter 9.

For clarity, BRPs and BSPs should note that the Settlement Bank agreement or the Pledged Cash Account agreement does not prevent the Settlement Bank from utilising its possible right to set-off accrued negative interest payable by BRP or BSP (if any) to the Settlement Bank under the terms and conditions of the Pledged Cash Account, if such negative interest will not be otherwise charged. However, if such set-off right exists and is being used by the Settlement Bank, BRP or BSP is still obliged to have sufficient funds on its settlement accounts for the settlement of their next invoice and to meet the collateral requirement as required.

The weekly activities related to invoices, payments, collateral, and currencies are summarized in **Table 24**.

Weekday	Activities
Monday	<ul style="list-style-type: none"> The settlement of the last day (Sunday) to be included in the invoicing round is finalized eSett calculates currency positions, makes FX forwards and converts invoice amounts (explained in section 8.8) eSett issues debit and credit notes to BRPs and BSPs by 13 CE(S)T eSett calculates and communicates updated collateral requirement to BRPs and BSPs by 13 CE(S)T BRP or BSP posts any additional collateral to meet the updated collateral requirement during Monday: <ul style="list-style-type: none"> Cash collateral to be deposited onto the settlement account during Monday so that it is included in Monday's closing account balance On-demand guarantees to be provided to eSett by 15 CE(S)T on Monday BRP or BSP provides sufficient balance on settlement account for settlement of next invoice if it is a debit note. Required amount to be deposited onto the settlement account during Monday so that it is included in Monday's closing balance
Tuesday	<ul style="list-style-type: none"> BRP or BSP to contact eSett if there are any issues with the invoice eSett issues corrected invoice if there was an error that eSett is responsible for
Wednesday	<ul style="list-style-type: none"> eSett debits the settlement account of the BRPs and BSPs that received debit notes
Thursday	<ul style="list-style-type: none"> eSett makes payments to BRPs and BSPs that received credit notes BRPs and BSPs receive the payments for their credit notes on their settlement accounts (provided that they have agreed with their settlement bank about receiving same-day-value payments)

Table 24. *Weekly activities related to invoices, payments, collateral, and currencies.*

8.6 Handling of Exceptions

Invoices and updated collateral requirements are published in the Online Service on Mondays by 13 CE(S)T. BRPs and BSPs need to post any required additional collateral during the same day. If updated collateral requirements are published later than 13 CE(S)T on Monday (invoicing day), any required additional collateral needs to be posted latest during the following day.

If there are one or more holidays during the invoicing cycle (Monday to Thursday), the invoicing activities on and after the holiday will be moved forward correspondingly so that there is always the same number of business days between the events: one business day between the invoicing day and the day when incoming amounts are debited and two business days between the invoicing day and the day when outgoing amounts are paid. A holiday in any of

the NBS countries will be treated as a holiday for the whole system in this regard. A holiday on a Monday before the Swedish reconciliation invoicing also causes the activities related to the reconciliation invoicing to move forward correspondingly to ensure that settlement invoicing and reconciliation invoicing won't occur on a same day.

If the finalization of the imbalance settlement is delayed due to some technical problem at eSett and all of previous week's settlement has not been finalized on Monday by the time the invoicing should take place, eSett will not invoice the incomplete week but rather delay the invoicing until all settlement data has been finalized. If the issuing of invoices is postponed from Monday to another day in the week, all other days in the invoicing cycle will also be postponed with an equal number of days so that there will be one business day between the invoicing day and the day when incoming amounts are debited and two business days between the invoicing day and the day when outgoing amounts are paid.

If a BRP or BSP notices an error in an invoice, which is caused by a mistake made by eSett, they should notify eSett thereof as soon as possible, at the latest during the same week as the invoice was issued. If it is possible to correct the invoice during the day after the invoicing (Tuesday), the corrected amount will be debited on Wednesday or paid out on Thursday. Otherwise, the original amount will be debited on Wednesday or paid out on Thursday and a correction will be debited or paid out after the corrected invoice has been issued. Due to the short time span between invoicing and debiting/payment, it is essential that BRPs and BSPs carefully verify the preliminary and finalized settlement and balancing service amounts as soon as they are available so that any errors in the settlement amounts can be identified and corrected well ahead of the invoicing. Invoicing errors that are caused by errors of the market participants or reported after the week when the invoice was issued will not be corrected by eSett. Such errors will instead have to be settled bilaterally between the contracting parties.

At the beginning of a new year, the invoicing period that contains the settlement from the delivery days at the turn of the year is split into two and two invoices are issued for that period: one with the settlement from the delivery days that fall on the old year's side and another one with the settlement from the delivery days that fall on the new year's side. The weekly fee will be divided respectively into the two invoices. Both invoices are issued on the same day and debited or credited according to the same schedule.

8.7 Value-Added Taxes

The imbalance energy, fees and activated reserves invoiced to the BRPs and BSPs by eSett are subject to value added tax (VAT) in all the Nordic countries. The tax rules and rates differ depending on the location where the buyer is VAT registered, the location where the seller is VAT registered, and the location of delivery. The VAT procedures in the Nordic Imbalance Settlement are based on the premises that eSett is established in Finland and that it acts as a commissionaire for the TSOs. Most BRPs and BSPs are established and VAT registered in the country where they act as BRP or BSP, but it is also possible for companies in other EU member states and Norway to act as BRPs or BSPs in Denmark, Finland and Sweden without local establishment and VAT registration. Due to Norwegian legislation, a local VAT registration is needed in Norway in order to buy and sell electricity in Norway. The different applicable VAT rates depending on the location of the party's VAT registration and the country of delivery are illustrated in **Table 25** and explained in the following subchapters.

Applicable VAT Rates in the invoicing of the imbalance settlement					
		Imbalance settlement in			
		Finland	Sweden	Denmark	Norway
BRP or BSP VAT registered in	Finland	VAT 25,5 %	VAT 25,5 %	VAT 25,5 %	Not possible *
	Sweden, Denmark, or other EU member state	VAT 0 %	VAT 0 %	VAT 0 %	Not possible *
	Norway	VAT 0 %	VAT 0 %	VAT 0 %	VAT 25 %

* Electricity trade in Norway requires local VAT registration

Table 25. Applicable VAT rates depending on registration location of BRP or BSP and country of delivery.

8.7.1 VAT on Invoices for Imbalance Settlement in Finland, Sweden and Denmark

As eSett is VAT registered in Finland, all the power that eSett sells to and purchases from other companies' VAT registered in Finland is subject to Finnish VAT, 25,5 % from 1 September 2024 (previously 24 %). The physical location of the delivery does not matter (unless the location is Norway, see section 8.7.2). If a company with VAT registration in Finland participates in the imbalance settlement in Sweden or Denmark, the invoice from eSett to this BRP or BSP for the imbalance settlement in that country will also be subject to Finnish VAT. Thus, the invoices for the imbalance settlement in Finland, Sweden and Denmark to companies with VAT registration in Finland will always have Finnish VAT.

When eSett sells power delivered in Finland or Sweden or Denmark to a company that is not VAT registered in Finland but in another EU Member State, such as Sweden, or outside EU, such as Norway, the transaction is not subject to Finnish VAT. Instead, the power is invoiced without VAT and the company is liable to account for VAT on behalf of eSett based on reverse charge (RC) rules. Likewise, when a company that is not VAT registered in Finland supplies power delivered in Finland or Sweden to eSett, the invoice is without VAT and eSett is liable to account for VAT on behalf of the company. This is based on Article 38 of the EU VAT Directive, which regulates the supply of electricity. Where the power was physically delivered is not relevant (unless the location is Norway, see section 8.7.2). Thus, the invoices to all companies that are VAT registered in Sweden, Denmark, Norway or other countries outside Finland will have 0 % VAT for the imbalance settlement in Sweden, Denmark and Finland.

8.7.2 VAT on Invoices for Imbalance Settlement in Norway

The VAT rules on supplies and purchases of energy differ in Norway as Norway is not an EU Member State. The liability for VAT follows the physical location of the delivery rather than the location of the buyer and seller. Thus, all imbalance settlement for energy delivered in Norway will be subject to Norwegian VAT, currently 25 %.

8.8 Currency Treatment

8.8.1 Choice of Invoicing Currency

Euro is the common currency in the imbalance settlement. The imbalances, activated reserves and fees are priced in euro and all settlement amounts are calculated in euro. Euro is also the default currency for the invoicing. However, BRPs and BSPs operating in Norway can alternatively choose to be invoiced in Norwegian krone (NOK), BRPs and BSPs operating in Sweden can alternatively choose to be invoiced in Swedish krona (SEK) and BRPs and BSPs operating in Denmark can alternatively choose to be invoiced in Danish krona (DKK). All BRPs and BSPs operating in Finland will be invoiced in euro.

If a company operates in more than one country, it can choose the invoicing currency separately for each country. If a company operates several BRP roles within a country, it can also choose the invoicing currency separately for each BRP role, if it so wishes. The choice of invoicing currency is done for at least one calendar year at a time. If a

BRP or BSP wishes to change the invoicing currency for the following year, it shall inform eSett of this no later than December 1st the current year.

8.8.2 Currency Conversions

For those BRPs and BSPs that have chosen to be invoiced in SEK, DKK or NOK, the settlement amounts are converted from euro to the local currency on the day when they are invoiced. On the same day (Monday), eSett will make the necessary foreign exchange transactions to cope with the fact that the amount of incoming funds in a currency will not equal the amount of outgoing funds in that currency. Amounts will be shifted from the one or two currencies where there will be a surplus (more funds coming in than going out) to the one or two currencies where there will be a deficit (more funds going out than coming in). These transactions will be forward transactions that settle on Thursday when the outgoing payments are to be made.

The foreign exchange rates that eSett obtains for these transactions will also be used for converting the invoice amounts from euro to SEK, DKK and NOK. This way there will be no currency gains or losses to eSett in the imbalance settlement. The foreign exchange rates are forward rates from Monday to Thursday quoted by the bank. The rates include a certain profit margin charged by the bank. No other fees will be charged for the transaction. Since the same rate is used for converting the invoice amounts from euro to local currency, the cost of the currency conversion will be fully passed on to those BRPs and BSPs that have chosen to be invoiced in the local currency. eSett will not take any margin on the currency conversions. There is also no need to charge any separate currency fee as there is no actual cost to eSett of the currency conversions.

9 Collateral and Risk Management

This chapter presents the approach for managing counterparty risk in the Nordic Imbalance Settlement Model including a description of the utilised collateral model, the calculation of collateral demands, as well as the approach to managing risks related to the settlement banks.

eSett is the financial counterpart in the imbalance settlement towards all BRPs. This gives rise to a significant counterparty risk for eSett. Each BRP must therefore provide collateral to eSett as security against the risk that the BRP is unable to fulfil its obligations towards eSett. The collateral helps to ensure that eSett can complete the imbalance settlement in an orderly manner at all times. Collateral can be provided in the form of a cash deposit on a pledged bank account or a bank guarantee. A BRP that is active only in the Danish market will not be asked to deposit collateral towards eSett. The Danish TSO Energinet carries all counterparty risk in the Danish market.

The Nordic Imbalance Settlement Model uses a dynamic collateral model. This means that the collateral requirements are recalculated every week based on the latest available settlement and price data. The requirements may further be adjusted at any time if eSett notices significant changes in the

counterparty risk profiles. The advantage of the dynamic collateral model compared to a static one is that collateral levels of the dynamic model are closer to the actual counterparty risk. Since the collateral requirements are recalculated when conditions change, the collateral formula does not have to include as much safety margin over the prevailing risk level as would be needed with a static model.

Provision of sufficient collateral is a precondition for the BRP to be entitled to access the electricity market. If a BRP fails to provide the required amount of collateral within the required time frame, this is considered a material breach of the Imbalance Settlement Agreement. Such a breach gives eSett and the TSO the right to take any necessary action to prevent losses and safeguard the power system, including the immediate termination of the Imbalance Settlement Agreement with the BRP and the exclusion of the BRP from the electricity market.

In addition to managing the counterparty risk vis-à-vis BRPs, eSett also monitors the settlement banks where the BRPs hold their settlement accounts and collateral. The purpose of this monitoring is to ensure that all settlement banks perform their services for the imbalance settlement in accordance with their agreement with eSett and to safeguard against the risk that the failure of a settlement bank could get to disrupt the imbalance settlement.

The BRPs are advised to carefully familiarize themselves with appendix 2 “Collaterals” of the imbalance settlement agreement. The collateral terms are stipulated in the agreement appendix, and if there is a contradiction between the appendix and the collateral chapters below in this handbook, the appendix shall prevail.

9.1 Counterparty Risk

Counterparty risk of eSett arises from the outstanding obligations of BRPs, i.e. from negative imbalances that have taken place but not been paid for yet. The counterparty risk vis-à-vis a BRP also includes the risk that the BRP is unable to pay for negative imbalances that accumulate from the current day onwards until the point when possible irregular behaviour can be identified, and the accumulation of further imbalances prevented. In the imbalance settlement eSett faces a significant time period of uncertain exposure. The counterparty risk for eSett will also vary substantially from time to time, depending on price levels and volumes of production and consumption. Continuous surveillance of trades compared to expected commitments and monitoring of other market developments, such as prices, is therefore essential.

9.2 Provision of Collateral

The BRP needs to provide collateral to eSett as security against the counterparty risk.

Collateral can be provided in the form of cash or an on-demand guarantee, or a combination of these. Any cash collateral shall be held in a bank that has been approved by eSett as a settlement bank for the imbalance settlement, and in the account designated to hold collaterals.

Any bank guarantee shall be unconditional, irrevocable and payable on first demand, and issued by an approved settlement bank.

eSett is entitled, if needed, to use the collateral to cover any outstanding commitments that the BRP is unable to fulfil within the time frame stipulated by the invoicing process presented in chapter 8.5.

9.3 Calculation of Collateral Requirement

The objective of the collateral model is to provide the best possible estimate of the prevailing counterparty risk exposure at any point in time based on the data available at the time. Excessively high collateral requirements would constitute a threshold for entering the market. The aim is therefore to set the collateral requirement at a level that provides adequate protection against the actual counterparty risk without being higher than necessary.

The overall counterparty risk exposure of eSett consists of the following components:

1. Delivery days for which the settlement amounts have been invoiced but not yet paid
2. Delivery days for which the settlement amounts are known but not yet invoiced
3. Delivery days during which the BRP has been active but the imbalances are unknown; only trade and imbalance adjustments are known
4. Delivery days in the future during which the BRP will be active, but for which there is no information yet about the BRP's activity; This component needs to be considered as well since there is the risk that a distressed BRP might cease to honour its commitments in the electricity market and accumulate significantly higher imbalances than normally until the point when this is noticed and the accumulation of further imbalances can be prevented

At the time of calculating the collateral, finalized settlement data is only available for components 1 and 2. The total exposure will therefore have to be estimated based on the best available data for this purpose.

9.3.1 Standard Formula

Under normal circumstances, the collateral requirement of a BRP is calculated according to the following standard formula:

$$\text{Collateral Requirement} = 3 * (S_1 + S_2) + m * (V_1 + V_2) * P$$

Where:

- S₁** = Average of the sums of invoiced volume fees and imbalance fees per week for the last three invoiced weeks, including any VAT on these amounts that the BRP is liable to
- S₂** = Average of the absolute amounts of the sums of invoiced imbalances in a week for the last three invoiced weeks, including any VAT on these amounts that the BRP is liable to. (How this is calculated: First we sum up the bought and sold imbalance in a week. Then we take the absolute amount of this sum. This is done for the last three invoiced weeks. Then we calculate the average of these absolute amounts.)
- V₁** = Consumption volume of the last seven settled days (current day minus 20 days to current day minus 14 days)

V_2 = Bilateral and PX market sales volumes during the last seven days for which such volumes are available (current day minus 8 days to current day minus 2 days)

m = Multiplier:

- 3/7 for the share of (V_1+V_2) that does not exceed 80,000 MWh
- 1/7 for the share of (V_1+V_2) that exceeds 80,000 MWh but does not exceed 400,000 MWh
- 0 for the share of (V_1+V_2) that exceeds 400,000 MWh

P = The last seven days average imbalance price for which such prices are available in the MBAs where the BRP is active. When calculating the average price, the negative prices are replaced by zero, and the price of each MBA is weighted according to the share of the BRP's total turnover (consumption, PX market sales and bilateral sales) during the last three invoiced weeks that took place in the respective MBA.

The first term of the formula $[3 * (S_1 + S_2)]$ provides an estimate of all the outstanding settlement amounts that have accumulated until the current day but not been paid yet. The length of the period with amounts outstanding varies during the week but is approximately three weeks on average. For the last two of these weeks, the settlement data is not finalized yet and therefore not available for use in the calculation of the collateral requirement. The collateral requirement is instead calculated based on the invoice data from the three last invoiced weeks, which means that the collateral requirement is mostly based on data that is older than the outstanding settlement amounts. Therefore, the collateral requirement does not directly represent the actual outstanding amounts at the time of calculation but is rather an estimate of what these amounts might be based on the available data. In this estimation, we must follow the uncertainty principle and take the absolute amount of the invoiced imbalance amounts. Even if the invoice amount was negative in one of the invoiced weeks, i.e. representing a receivable of the BRP from eSett, which in principle would not require any collateral, the currently accumulating imbalances that the collateral should cover might as well occur in the opposite direction.

The second term of the formula $[m * (V_1 + V_2) * P]$ provides an estimate of the forward-looking component of the exposure, i.e. the imbalances that a misbehaving BRP may accumulate from this point onwards until the point when the irregular behaviour can be identified and the accumulation of further imbalances prevented. The calculation is based on the worst-case assumption that the whole turnover of the BRP may turn into imbalance. The length of the forward exposure is approximately one day during the week but increases to three days on Friday since the same amount of monitoring does not take place during weekends. The formula therefore counts with three days of exposure (multiplier 3/7) for volumes up to 80,000 MWh. For the share of the volume that exceeds 80,000 MWh, a smaller multiplier of 1/7 is used. This is mainly because any possible misbehaviour of larger BRPs is easier to recognise and thus quicker to prevent. The volume used in the calculation is capped at 400,000 MWh in order to prevent excessively large collateral requirements for the largest BRPs.

Minimum collateral requirement is 40 000 € per country and it can not be compensated by collateral in another country. If calculated collateral requirement is lower than the minimum requirement, then the minimum requirement will be used.

9.3.2 Deviations from the Standard Formula

In certain situations when the standard formula does not appropriately reflect the counterparty risk, eSett may adjust the collateral requirements to better reflect the prevailing risk. The following are examples of situations when this is necessary to do:

- a) **Public holidays** – When the invoicing or payment of outstanding settlement amounts will be delayed due to public holidays, this will lead to the accumulation of exposures from a larger amount of days than normally before payment can take place. The forward-looking risk will also increase if there is a larger number of days than usually when normal monitoring cannot take place. In these cases, the standard formula is adjusted to account for the exposures from the additional days in the settlement process.
- b) **Delays in payments** – Sometimes there may be an apparent risk that the invoicing or payment of outstanding settlement amounts may be delayed, for example due to labour disputes affecting banks or

other institutions that are part of the settlement process. In such cases the standard formula is adjusted to account for the exposures from the estimated number of additional days in the settlement process.

- c) **Market changes** – Sometimes when substantial changes have taken place or can be expected in the PX Market or Regulation Power Markets, the quoted prices in these markets may no longer be representative of current or future price levels. In such cases the standard formula is adjusted by replacing the average regulation market price from the last seven days with an estimated price that better reflects the current or expected price levels.
- d) **Delays in PX market calculation** – If NEMOs are unable to calculate the following day's results in a normal order, then higher imbalance amounts and regulation prices can be expected. In such cases the PX market program is copied from the last usable day and used for the following day and the collateral formula and regulation price are adjusted to cover the increased settlement risk.

There are also situations when the standard formula is not applicable for a particular BRP or does not appropriately reflect the counterparty risk of the BRP. In such situations, eSett may calculate the collateral requirement for the BRP according to a different formula, which better reflects the counterparty risk prevailing in that particular situation. The following are examples of situations when this is necessary to do:

- a) **New BRP** – When a new BRP enters the market, eSett will calculate a preliminary collateral requirement based on documentation of planned balance, expected volumes of trade and consumption, and credit rating, if any. The minimum amount of collateral for a new BRP is 40,000 EUR.
- b) **BRP with changed portfolio** – When a BRP's portfolio undergoes substantial changes, for example as a result of a merger, acquisition or divestment, the BRP must provide eSett with necessary information of expected changes in traded volumes, based on which eSett will calculate an adjusted collateral demand. The volume parameters in the calculation are adjusted to cover any uncertainty pertaining to the change in the balance responsibility. The standard collateral formula will be used again when an adequate amount of trade has been completed with the new portfolio.
- c) **Participant in shadow auction** – Some BRPs participate in shadow auctions that are used to allocate cross-border capacities e.g. on the NorNed link in case of technical problems at the European Market Coupling Company (EMCC). These BRPs are provided with an additional fixed-term collateral requirement that correspond to the additional settlement risk.
- d) **BRP with erroneous volume data** – Sometimes there may be known errors in the volumes reported by a BRP, which cause substantial errors in the collateral requirement for the BRP. In such cases the imbalance volumes can be adjusted to the imbalance volumes of the last two settled weeks.
- e) **BRP in financial distress** – When there are signs that a BRP is in financial distress, i.e. there is evidence of an increased risk that the BRP may not be able to meet its financial obligations towards eSett, eSett will take necessary actions to minimize the risk of credit loss. In such cases eSett will calculate a new specific collateral requirement based on the following:
 - Documentation of planned balance
 - Documentation of conditions for continued operation
 - Trading behaviour
 - Credit rating

9.4 Collateral of BRPs Operating in Multiple Countries

If a BRP operates in multiple countries, eSett will publish a single collateral requirement for the BRP, which covers the counterparty risk arising from the BRP's operations in all these countries. This collateral requirement is the sum of the individual collateral requirements for each country, which are calculated as described in chapter 9.3 based on

the BRP's invoices and data for respective country. If the BRP has different settlement accounts per country, the account balance of each settlement account is taken into account as collateral. The sum of all individual collateral deposits must meet the collateral requirement.

9.5 Currency Treatment

All collateral requirements are calculated and published in euro. Cash collateral and on-demand guarantees can be denominated in euro, Norwegian krone (NOK), Swedish krona (SEK) or Danish krone (DKK). For the purpose of collateral monitoring, the value of any collateral denominated in NOK, SEK or DKK is converted to euro using the latest available reference rates from the European Central Bank.

9.6 Collateral Management Procedures

Collateral requirements are calculated by eSett each Monday and published in the Online Service by 13 CE(S)T on Monday. eSett will further monitor the risk exposures during the week and recalculate the collateral requirements if necessary. If collateral requirements are updated during the week, eSett will publish the updated collateral requirements by 13 CE(S)T on that day. New collateral demands are not published on holidays in the Nordic calendar. The BRPs shall check their collateral requirement in the Online Service on a daily basis and arrange for additional collateral with their settlement bank whenever necessary.

The BRP must provide sufficient collateral to meet the collateral requirement during the day when the updated collateral requirement was published. Any additional Cash Collateral shall be transferred to the account during the banking day so that it gets included in the account balance of that day. Any additional on-demand guarantee shall be provided to eSett by 15 CE(S)T.

To be able to monitor the collaterals, eSett will retrieve the account balances of the BRPs' accounts from the settlement banks on a daily basis. When needed, the settlement banks will also confirm to eSett any changes in the posted collaterals during the day.

9.7 BRPs with Insufficient Deposited Collateral

If a BRP should fail to provide the required amount of collateral within the required time frame, this is considered a material breach of the Imbalance Settlement Agreement. If such a breach occurs, eSett in cooperation with the concerned TSO(s) have the right to take any necessary action to prevent losses and safeguard the power system. The BRP will be contacted and asked to urgently clarify its situation. If the BRP is unable to remedy the deficiency in its collateral, this will lead to the immediate termination of the Imbalance Settlement Agreement with the BRP and the exclusion of the BRP from the electricity market.

9.8 Release of Collateral

If the amount of collateral provided by the BRP exceeds the collateral requirement, the BRP may request from eSett that the exceeding part of its collateral is released. Such requests can be made through the Online Service on any day of the week. If the request is valid, eSett will instruct the BRP's settlement bank to transfer the funds to BRP's other account. The settlement bank will not allow the BRP to withdraw any funds from its pledged settlement account or cash collateral account.

The BRP has to inform eSett about the account to be used for releasing the excess collateral when Pledged Settlement Account Model is used. If the Pledged Settlement Account Model is used, the collateral release account will be updated by the BRP through Online service at the same time as the settlement account (see chapter 8.4 about updating the settlement account). The BRP will also send eSett the Standard payment instructions signed by the signatory authorized to act on behalf of the BRP. eSett compares the Standard payment instructions with the collateral release account number updated through Online service. After verifying the release account number this

way, eSett approves of it in the system. If BRP uses Cash Settlement Account Model, collateral is released to the Cash Account. Requests to release collateral are processed from Tuesday to Friday. Requests to release excess funds are not processed on holidays in the Nordic calendar.

If the Imbalance Settlement Agreement is terminated, eSett is entitled to withhold the collateral until the BRP has fulfilled all its obligations under the agreement and if necessary, to use the collateral to cover any unsettled commitments that the BRP is unable to fulfil. Any remaining collateral will be released to the BRP after the final settlement has been performed.

While it is acknowledged that any (positive) interest accrued to the funds on the Pledged Bank Account (if any) is in the scope of the pledge under the Pledged Cash Account Agreement it is stated for clarity, that the Settlement Bank Agreement or the Pledged Cash Account Agreement does not prevent the Settlement Bank from utilising its possible right to set-off accrued negative interest payable by the Account Holder (if any) to the Settlement Bank under the terms and conditions of the Pledged Cash Account if such negative interest will not be otherwise charged.

9.9 Monitoring of Settlement Banks

In addition to managing the counterparty risk vis-à-vis BRPs, eSett also needs to ensure that the settlement banks are able to fulfil their roles in the settlement process. eSett also needs to safeguard against the risk that the failure of a settlement bank could get to disrupt the imbalance settlement. For this purpose, there are certain requirements that a bank must fulfil in order to be approved as a settlement bank for the imbalance settlement:

- The bank needs to be rated by at least one of the three major rating agencies (Fitch, Moody's or Standard & Poor's) and the rating (or the majority of the ratings, if several) must be on A level⁵.
- If the Settlement Bank is rated by several agencies, at least one of the ratings must be on the aforementioned level and the lowest rating must be at least BBB+ (Fitch, Standard & Poor's) or Baa1 (Moody's).
- The bank needs to commit to executing the requests for transfers that eSett issues through its main bank
- The bank needs to commit to reporting the BRP's account balances to eSett
- The bank needs to have the technical capabilities to exchange the necessary messages with eSett's main bank for the request for transfer and balance reporting services
- The bank needs to sign necessary agreements with eSett and eSett's main bank

eSett monitors the credit ratings of the settlement banks as well as the services performed in order to ensure that the banks comply with the requirements of the Imbalance Settlement. If a settlement bank is unable to maintain the required credit rating or to provide the agreed services in an adequate manner, eSett will take steps to exclude the bank from the list of approved settlement banks and the BRPs that have used this bank will have to move their settlement accounts and collaterals to another approved settlement bank. If there are signs of non-compliance with the requirements, the bank will first be placed on a watch list. The watch list is published in the Online Service to give concerned BRPs pre-warning that they should prepare for the possibility that the bank may get excluded from the list of approved settlement banks. If a settlement bank gets excluded, the BRPs need to complete the move to another approved settlement bank within three months.

9.10 Collateral Management Related to the Reconciliation Invoices

The above-described procedures related to the collateral management and calculations will not be applied for the reconciliation. Such invoices will be based on the result provided by SvK. This means that volumes and amounts

⁵ Standard & Poor's: long term rating at least "A-"
Moody's: long term rating at least "A3"
Fitch: long term rating at least "A-"

that are part of the reconciliation will not be part of the collateral calculation. Furthermore, direct debit will not be applied for these invoices. Currency will be SEK or EUR.

9.11 Collateral Management of BSPs

BSPs cause a counterparty risk for eSett from the outstanding obligations, i.e. purchase of activated reserves from eSett (down regulation) that have taken place but not been paid for yet. The counterparty risk vis-à-vis a BSP also includes the risk that the BSP is unable to pay for purchased activated reserves that accumulate from the current day onwards until the point when possible irregular behaviour can be identified, and the accumulation of further costs prevented. The counterparty risk for eSett will also vary substantially from time to time, depending on price levels and volumes of activated bids.

Nordic TSOs reserve the right to require collateral from the BSPs. Each TSO will define the locally used collateral regime until a common Nordic collateral model has been defined. More detailed information about the collateral requirement for BSPs shall be provided and will be presented in the Balancing Service settlement Agreement's Appendix 2 - Collaterals if any of the Nordic TSOs decide to apply the requirement nationally.

Collateral for BSP which also act as a BRP shall be covered by the existing dynamic collateral requirement for the BRPs. BSPs that don't also have a BRP role will have a risk-based defined and manually set collateral requirement if such is required by the local TSO.

10 Communication

This chapter presents how the communication between stakeholders in the Nordic Imbalance Settlement is arranged. The different communication channels with eSett and the reporting provided by eSett are presented.

The communication between market participants and eSett is enabled largely by eSett's imbalance settlement IT system which is the core of eSett's activities. The main communication channels to and from eSett are the Messaging service, Online Service and the Information Service. Content-wise the communication is mainly of sharing settlement data between required stakeholders, but also of various reports with information on the imbalance settlement and the performance of the market.

A common data communication standard for the market messaging has been developed for the NBS (see chapter 10.4 for further information). The purpose of the common messaging standard is to ensure that imbalance settlement information exchange of plans, trades, deliveries and meter readings is

based on the same communication technology and formats in order to distribute the settlement information fluently between all market participants in the Nordic countries.

The Online Service is the primary interface towards BRPs and other market participants. Settlement information from eSett is published to the service, in order for market participants to view and download the information they are entitled to. The Online Service consists of both a public part, where public settlement information is published, and a restricted part that requires login and contains settlement information that only the respective market participants can view. Market participants can also send information to eSett via the Online Service and for example manage their collaterals and invoice information. In addition, it is possible to extract published data and order data packages from the service.

All basic needs for settlement data from eSett are covered with automatic data flows from messaging service and data packages, described in chapter 10.2. In addition, eSett offers Market Participants the possibility to download new or updated settlement data from the imbalance settlement IT system directly to their own IT systems through Information Service. The Information Service is established as a machine-to-machine connection between market participant's and eSett's system. To be able to utilise the Information Service, the market participants must first be authorised according to eSett requirements. The market participants can download time series data through the Information Service and only such data that the market participant is entitled to view. More information regarding Information Service can be found in the document Communication Guidelines, placed at eSett's web page (<https://www.esett.com/customers/data-communications/>).

There will be at least two full years of settlement data available in the settlement system. The amount of available settlement data will be limited by archiving the data and deleting old archives. Archiving and archive deletion is a preventive measure to mitigate the growth of data. This helps to guarantee seamless and cost-effective operation and system performance. Archiving will be done once a year for data older than two calendar years. Data will be stored on archives for seven years and after that archives older than seven years will be deleted once per year.

10.1 Messaging Service

Messaging Service enables eSett and Market Parties to exchange messages necessary for the Settlement process. It is used both for inbound messages, such as meter values sent from the DSOs, and outbound messages, such as the settlement result to the BRPs. In order to ensure that imbalance settlement information exchange is based on the same communication technology and formats, a common data communication standard has been developed, which is presented in chapter 10.4.

eSett will communicate via SMTP, SFTP, web service or ECP when messages are sent to and from eSett by messaging service. Swedish and Norwegian market participants will use SMTP, Finnish market participants may use any channel and Danish market participants are recommended to use ECP.

10.2 Data Packages

Data packages are a functionality that enables market participants (BRPs, BSPs and DSOs) to receive settlement data by subscription. eSett defines the content of a data package and also defines when the data packages will be compiled and sent out automatically. After this, eSett adds the newly defined data package to the list of available data package on the Online Service. The market participants can then go to the Online Service and “order/subscribe” the data package. According to the distribution schedule that eSett has defined, the eSett settlement system compiles and sends the packages via messaging service. The data packages are created per market participant role so that each package is populated only with the data that the market party is entitled to see. Generally, data packages will be sent to the market participants on daily basis, with same granularity as the settlement is calculated and include settlement data from open imbalance settlement period as well as the final data for closed settlement period.

Data packages are divided into “specific” and “generic”. The specific data packages will utilize the same data flows as Information Service and those are presented in the Communication Guidelines. The generic data packages will utilize generic format (e.g. most of the settlement aggregation time series will use the generic data format). The generic format is defined in the Communication Guidelines.

Additionally, eSett provides data packages in UTILTS format regarding the profiling and reconciliation in Sweden. These are defined in the UTILTS & APERAK guide which can be found from Swedish Edielportalen: <https://www.ediel.se/Info/edielanvisningar>.

Data package	Description	Market Participant
Metering Grid Area (MGA) losses per MGA	MGA losses of those MGAs DSO is responsible	DSO
MGA imbalances	Calculated imbalances of those MGAs DSO is responsible	DSO
MGA imbalances	Calculated imbalances of those REs' BRP is responsible	BRP
Production per production unit (PU)	Production of those PUs' DSO is responsible	DSO
MGA exchange sums	MGA exchange sums between two adjacent MGA and for those DSOs related to the sum	DSO
MGA exchange confirmation report	MGA exchange's matched values and delta values between two adjacent MGA	DSO
REs' consumption data per type and MGA	REs' consumption for those MGAs DSO is responsible	DSO
REs' consumption data per type and MGA	REs' consumption for those REs BRP is responsible	BRP
RE's merged production data per type and MGA	REs' merged production for those MGAs DSO is responsible	DSO
RE's merged production data per type and MGA	REs' merged production for those REs BRP is responsible	BRP
Production plan per BRP and RO		BRP
Production per production unit (PU)	BRP RE's production per PU	BRP
Bilateral trades	Bilateral trades of BRP's balance responsibility	BRP
Bilateral trade confirmation report	Bilateral trade's matched values and delta values between two involved BRPs	BRP
Imbalance prices per Market Balance Area (MBA)		BRP and BSP
FRR-A volume-weighted average price per Market Balance Area (MBA)	A volume-weighted price from the European aFRR energy activation market (PICASSO) per ISP	BRP and BSP
Imbalance per BRP per MBA (volume and amount)	Imbalance settlement results as volumes (MWh) and amounts (EUR, DKK, NOK or SEK)	BRP
Activated reserves per subtype		BSP
Capacity reserves per subtype		BSP
PX Trades	Day-ahead, Intraday and Day-ahead (NSL) trades of the BRP's responsibility	BRP

Table 26. *Specific Data Packages.*

Data package	Market Participant
Aggregated consumption per BRP and MBA	BRP
Aggregated consumption per type per BRP and MBA	BRP
Aggregated consumption per RE and MGA	BRP
Aggregated minor production per BRP and MBA	BRP
Aggregated production plan per BRP and MBA	BRP
Aggregated bilateral trade purchase per BRP and MBA	BRP
Aggregated bilateral trade sales per BRP and MBA	BRP
Aggregated day-ahead purchase per BRP and MBA	BRP
Aggregated day-ahead sales per BRP and MBA	BRP
Aggregated day-ahead (NSL) purchase per BRP and MBA	BRP
Aggregated day-ahead (NSL) sales per BRP and MBA	BRP
Aggregated intraday purchase per BRP and MBA	BRP
Aggregated intraday sales per BRP and MBA	BRP
Aggregated day-ahead flow import per BRP and MBA	BRP
Aggregated day-ahead flow export per BRP and MBA	BRP
Aggregated day-ahead (NSL) flow import per BRP and MBA	BRP
Aggregated day-ahead (NSL) flow export per BRP and MBA	BRP
Aggregated intraday flow import per BRP and MBA	BRP
Aggregated intraday flow export per BRP and MBA	BRP
Aggregated MGA imbalance surplus per BRP and MBA	BRP
Aggregated MGA imbalance deficit per BRP and MBA	BRP
Aggregated consumption imbalance adjustment up per BRP and MBA	BRP
Aggregated consumption imbalance adjustment down per BRP and MBA	BRP
Aggregated MGA trade import per BRP and MBA	BRP
Aggregated MGA trade export per BRP and MBA	BRP
Aggregated pump storage consumption per BRP and MBA	BRP
Aggregated normal production per BRP and MBA	BRP
Aggregated production imbalance adjustment up per BRP and MBA	BRP
Aggregated production imbalance adjustment down per BRP and MBA	BRP

Table 27. *Generic Data Packages.*

Data package	Description	Market Participant
Preliminary Loadshare per MGA per BRP per type	Reported Preliminary Loadshares per MGA per BRP per Consumption Type (General, Losses) including Total Preliminary Loadshare per MGA	BRP
Load Profile per MGA	All Load Profiles per MGA in Sweden	BRP & DSO
Load Profiles per own MGA	Load Profiles for all DSO's own MGAs, or Load Profiles for BRP per MGA where BRP has Loadshares	BRP & DSO
Final Loadshare per MGA per BRP per type	All BRP's reported Final Loadshares per MGA per BRP per type	BRP
Profiled Imbalance per MGA	BRP's Profiled Imbalance per MGA where BRP has Losses	BRP
Reconciliation Quantity and Amount per MGA per BRP	Reconciliation Quantity and Amount per MGA per BRP	BRP
Reconciliation Quantity and Amount per Country per BRP	Reconciliation Quantity and Amount per Country per BRP	BRP
Invoiced Reconciliation Quantity and Amount per MGA per BRP	Invoiced Reconciliation Quantity and Amount per MGA per BRP for the month in SNT	BRP
Profiled Consumption per MBA per BRP	Aggregated Profiled Consumption per MBA in Sweden for BRP	BRP
Profiled Consumption per MGA per BRP	Profiled Consumption per MGA per BRP per ISP	BRP
Profiled Consumption per MGA per BRP (month)	Aggregated Profiled Consumption per month per MGA per BRP	BRP
Reconciliation Price	Reconciliation Price per MBA	BRP

Table 28. UTILTS Data Packages for Swedish profiling and reconciliation.

10.3 Information Service

eSett gives market participants the possibility to retrieve settlement data (time series data) from an Information Service. The Information Service is established as a system-to-system connection between market participant and eSett.

The service is established as a web service, which provides the possibility for data requesting and transfer but also capabilities for information security; secure connection between two system and tools for market participant's authentication and authorisation. If the market participant wants to use the Information Service, it needs to set up the connection with eSett.

The market participants must first be authorised to use the Information Service. After authorisation, a market participant can fetch time series data through the Information Service. Market participant can only fetch data that the party is entitled to view, as instructed in the regulations.

The market participant's IT system can send a request for MEC data to the Information Service in order to receive it. A market participant can for example order following MEC data: detailed production plans, detailed reserves data, settlement data, settlement results or imbalance prices. The Information Service provides the requested data to market participant's system if the requested data is available.

The information that can be received via the Information Service is shown in **Table 29**.

Information service tasks	
Market participant	Task
BRP	<ul style="list-style-type: none"> Receive settlement data (e.g. time series data for MEC data, detailed production plans, detailed reserves data, settlement calculation results, imbalance prices)
BSP, DSO, TSO, NEMO, RE	<ul style="list-style-type: none"> Receive settlement data (e.g. time series data)

Table 29. Available information service tasks per market participant.

Detailed information regarding the Information Service interface and the supported data flows can be found in the Communication Guidelines, published on eSett's web page (<https://www.esett.com/customers/data-communications/>)

10.4 Data Communication Standards

The common file format syntax will be based on ENTSO-E and ebIX®. Definition of the utilized file format is specified in the document "A market model for data exchange, Business Requirement Specification for Data Exchange in NBS (BRS)". The focus of the BRSs for the Nordic Balancing System is the business aspects of the document exchanges. The latest version of the document can be found at: <https://ediel.org/>.

Market participants responsible for reporting data to eSett are obliged to use the common standard, as stated in section 5.1 Reporting Requirements.

The TSOs have prepared a user guide for NBS. The User Guide for XML documents for NBS is a detailed User Guide for the ENTSO-E and ebIX® XML documents used in the Nordic Balancing System. The focus of the document is the technical aspects of the documents to be exchanged. In addition, NMEG has also prepared a document with XML schemas and examples. The latest version of the documents can be found at <https://ediel.org/>.

10.4.1 Data Communication Encryption in WS, SFTP and SMTP Channels

Communication towards eSett can be encrypted or non-encrypted and towards market parties it is configured based on capabilities of receiving party. The supported protocols (WS, SFTP, SMTP) allow authentication and encryption of the data exchange using either TLS or SSH. The process of authentication and encryption is completely controlled by the transport technology (and underlying libraries), the security information (username/password) are passed to these technologies by means of specific configuration. In Sweden, TLS encryption is required when settlement data is sent to eSett.

10.4.2 Data Communication Encryption in ECP/EDX Channel

On the sender's Endpoint each new message is encrypted using a uniquely key generated by symmetric cryptography (session key), the used key bit-length is obtained from the configuration. The session key is encrypted using X.509 public key of recipient Endpoint. The Message Encryptor obtains the X.509 public key from the Component Directory. The encrypted session key is transported together with the message from the sender Endpoint to the recipient Endpoint.

On the recipient Endpoint the session key is decrypted using X.509 private key of the recipient Endpoint. The Message Encryptor obtains the X.509 private key from its local keystore. The message payload is decrypted with the decrypted session key.

As the symmetric cipher, the AES algorithm is used. The supported key sizes are 128, 192, and 256 bits. The used symmetric cryptography key size can be set differently on each Endpoint in its configuration. ECP uses 2048-bit length keys for asymmetric cryptography.

10.4.3 Communication Coding Schemes for the Market Participants

The market participant is required to use one single coding scheme per country towards eSett in all communication. This can be for example EIC, GS1 codes or a code based on a national scheme. If a market participant is active only in a one country it can use the national coding scheme, but if market participant is active in more than one country it has to use EIC or GS1. If market participant is active in Norway, a Norwegian GS1 (GLN) code must be used. Detailed communication coding schemes are described in the BRS, which can be found at <https://ediel.org/>.

As stated in the chapter 3.2.1 for unbundling reasons the retailer and distribution system operator businesses are separated to own companies and it is necessary to model them as two separate companies also in NBS model and eSett's imbalance settlement system. Consequently, these companies cannot utilize same market participant codes.

For messaging and data exchange purposes a coding scheme and market participant code will be determined for each market participant role.

In Norway and Sweden, the same market participant code can be used for RE, BRP and BSP roles that are connected to the same company. If there's a DSO role connected to the same company, it needs to use different market participant code for that role.

In case of service providers, it is defined for which market participants the service provider provides the imbalance settlement services. When service provider sends messages to eSett (as a service to its customer) it will use the market participant codes based on its customers' role and not service provider's own code.

In Finland, the same national market participant code can be used for roles that are connected to the same Company. E.g., a balance responsible company in Finland can use the same national market participant code for its BRP, BSP and RE roles as well as for its DSO role for its non-concessional grids (e.g. production metering grid areas). However, with GS1 (GLN) codes, the DSO role needs to have its own unique code, while BRP, BSP and RE may still use same code if they are connected to the same company.

Fingrid is a responsible issuing body for giving national and EIC coding schemes for the market participants and GS1 Finland Oy is an issuing body for giving GS1 coding scheme in Finland. In a situation where a Finnish market participant is active in more than one country in NBS the Finnish market participant has to use either EIC or GS1. Additionally, the Finnish Datahub requires that market participants in Finland have to use GS1 (GLN) codes unless they are outside the scope of the Datahub.

All Danish Market participants have a GLN code, and this is the only possible for DSOs and Retailers. BRP's and BSPs are allowed to use EIC codes as well. In Denmark, the same market participant code can be used for RE, BSP and BRP roles that are connected to the same company.

Table 30 compiles the requirements for allowed coding schemes per type for each NBS country.

Allowed Market Party coding schemes per country			
Country	GS1 (GLN)	EIC	National
Denmark	X	X	
Finland	X	X ⁶	X ⁶
Norway	X ⁷		
Sweden	X	X	X

Table 30. Allowed market participant coding schemes per country.

⁶ Only for market participants outside of the scope of the Finnish Datahub. For example, a BRP or RE that has only trades, or a DSO with only a production grid and no connection to distribution or transmission grids.

⁷ A Norwegian GS1 (GLN) code must be used in Norway.

10.5 Open Data

Open Data is eSett’s primary interface to other stakeholders than market participants. The Open Data can be accessed without a user account or authentication. The information provided there gives a basic knowledge about imbalance settlement and the companies involved in it.

The Open Data contains information presented in **Table 31**.

Information in the Open Data
List of active market participants and their roles
List of active MGAs and their DSOs, types and MBAs
The active Retailer Balance Responsibility relations per type in different MGAs
Approved Settlement Banks
Imbalance energy volumes for each ISP per MBA (only Finland and Norway)
Consumption volumes for each ISP per MBA per metering type
Production volumes for each ISP per MBA per production unit type
Price information for each ISP per MBA
Fees
Load profile volumes for each ISP per MGA in Sweden (from 1.11.2023)
Reconciliation prices for each month per MBA in Sweden (from 1.11.2023)

Table 31. *Information in Open Data.*

10.6 Online Service

The Online Service is eSett’s main communication tool and primary interface to market participants. The Online Service requires login and contains settlement information that only the respective market participants can view.

Settlement information from the imbalance settlement IT system is published at the Online Service, so that market participants and authorized service providers can view and download the information they are entitled to see. The Online Service provides a functionality for update of structure information and upload of settlement data. The user is also able to monitor messaging related to the market participant.

The Online Service focuses on the needs of the companies (and market participants) that are involved in the imbalance settlement or balancing services and provide them with all the data that are included in their settlement. The market participants are able to have the complete overview of the imbalance settlement input and result, thus enabling them to perform a full verification over their entire settlement.

The market participants and their service providers are able to send and update information to eSett’s imbalance settlement IT system. This includes both time series and structure data. Functionality for management of their collaterals and invoice information is also provided and it is possible to download data in different forms. The tasks that market participants can perform in the Online Service are presented in **Table 32**.

Online Service features	
Market participant	Task
RE	<ul style="list-style-type: none"> • Manage contact information • View current and historical structure information • View and download settlement data (time series)
BRP	<ul style="list-style-type: none"> • Manage contact information • Register, update, close structure information • View current and historical structure information • Upload, change, view and download settlement input data • View invoice information (fees, prices, amounts) • View and update collateral management information • Report and update bilateral trade within given timeframe • View and download settlement data (time series, balance report, production plans, settlement results and MGA imbalances) • View monitoring and KPI information
BSP	<ul style="list-style-type: none"> • Manage contact information • View current and historical structure information • View and download balancing services data (time series) • View invoice information (fees, prices, amounts) • View and update collateral management information
DSO	<ul style="list-style-type: none"> • Manage contact information • Register, update, close structure information • Upload, change, view and download settlement input data • View current and historical structure information • Report and update MGA exchange within given timeframe • View MGA imbalances • View and download settlement data (time series, balance report and MGA imbalances)

Table 32. *Online Service features for market participants.*

10.6.1 Online Service User Account

eSett grants an initial right to use, i.e. access to, the Service. There are two types of Users in the Online Service:

- Online Service Administrator – user has access to User Management, Service Outsourcing and Company management use cases
- Online Service User – user is a regular User of a company, having read and/or edit access to imbalance settlement related data including collaterals management

Each Online Service user must have a personal user account with login and password information to access the restricted part of the service. Upon first login, each user needs to read, accept and commit to comply with the [Terms of Use](#).

The User(s) use the Service at his own risk and shall be liable for all use in the Service under his username and password and for the use conforming to the Terms of Use. The User shall keep the username and password confidential.

In accordance with the applicable legislation, shall the User use the Service in good faith and always comply with good business practices.

The User agrees not to use the Service for sending or forwarding any material, which is contrary to law or good practice, to incite this or to promote it. The User may not disclose information published in the Service to any third party. The User is responsible for acquiring and maintaining all hardware, software and data communications

connections required by his/her use of the Service as well as for other expenses caused by the use of the Service. Furthermore, it is the User's sole responsibility to ensure a proper and secure configuration of its connection to the Service.

The User shall be fully liable for damage or loss inflicted on eSett, other Users and third parties as a result of non-compliance of the Terms of Use, any applicable law or good business practices.

10.6.1.1 Online Service Administrator

Each company (or market participant) has to have an Online Service administrator. The administrator user has access to User Management, Service Outsourcing and Company management use cases as well as read and edit access to all market parties and functionalities related to the user's company.

10.6.1.2 User Management

eSett will give user rights to the company's Online Service Administrator. The Online Service Administrator is responsible for granting access and maintaining Online Service User accounts of other Users in the company that the Online Service Administrator represents. The Online Service Administrator ensures that access is only given to persons who have a legitimate, work-related need for using the Service. The Online Service Administrator and Online Service User are also responsible for ensuring the confidentiality of their accounts and password.

Online Service Administrator has an obligation to deactivate Online Service User accounts that are no longer needed due to termination of employment of a User, or other similar reasons.

eSett may also maintain the userbase by ensuring that users who no longer use the system will eventually be removed based on a predefined cycle. Users with an expired password shall be changed from active to inactive status after four (4) months' time. Users who have had the inactive status for three (3) months may be deleted automatically. Online Service Administrators can reactivate users with inactive status in the Online Service.

The administrator from the company creates the following users in the Online Service. The following information is required for a user account:

- Name
- Contact information (e-mail, phone number for SMS authentication)
- Company
- Online Service user access rights

Online Service Administrator assigns the correct roles and access rights.

After the user account is created and activated, an automatic invitation is sent to the new Online Service user.

10.6.1.3 Access Rights

The User(s) has access only to data of market participants registered under their company or only to data of market participants served by their company as a service provider. The use of the Service is protected by a user account with username and password requiring a two-factor authentication.

The access rights to the settlement information are strictly regulated by the Nordic regulators and the IT system's access management supports the regulation on this point. Following access rights are defined:

- Primary Access Right – access right to market parties of the user's company.
- Secondary Access Right – access right to market parties that the user's company provides services to. These are relevant only for users of service provider companies.

The access rights are connected to the following market party groups:

- Market Activity Group – BRP, BSP and RE MPs.
- Grid Activity Group – DSO MPs.

Due to the unbundling rule, a user is only allowed to switch between market parties within one market party group after logging in.

- On user level it is decided whether the user has only read or read and write rights.

10.6.1.4 User Roles

User role allows user to give access to predefined sets of functionalities of the Online Service. A market party can have service providers linked to these different roles.

- Market Role: Allows the user to use functionalities related settlement structures and MECs of one market party.
- Collateral Role: Allows the user to use functionalities related to bank accounts and collateral deposits.
- Invoice Role: Allows user to use functionalities related to invoices.
- External interface role: Allows the users to insert messages directly into the service

10.7 Example of Information Access Rights in the NBS Model

The example in **Table 33** shows what settlement information regarding MGAs the BRPs, DSOs and REs can view and update in the NBS model.

The example is based on the assumption that:

- BRP1 is a BRP for
 - RE1 consumption in MGA1
 - RE2 production in MGA1
 - RE3 losses in MGA1
 - BRP1 imbalance in MGA1
 - RE2 consumption in MGA2
 - BRP1 (as a RE) consumption in MGA2
- BRP2 is a BRP for
 - RE4 production in MGA2
 - RE5 losses in MGA2
 - BRP2 imbalance in MGA2

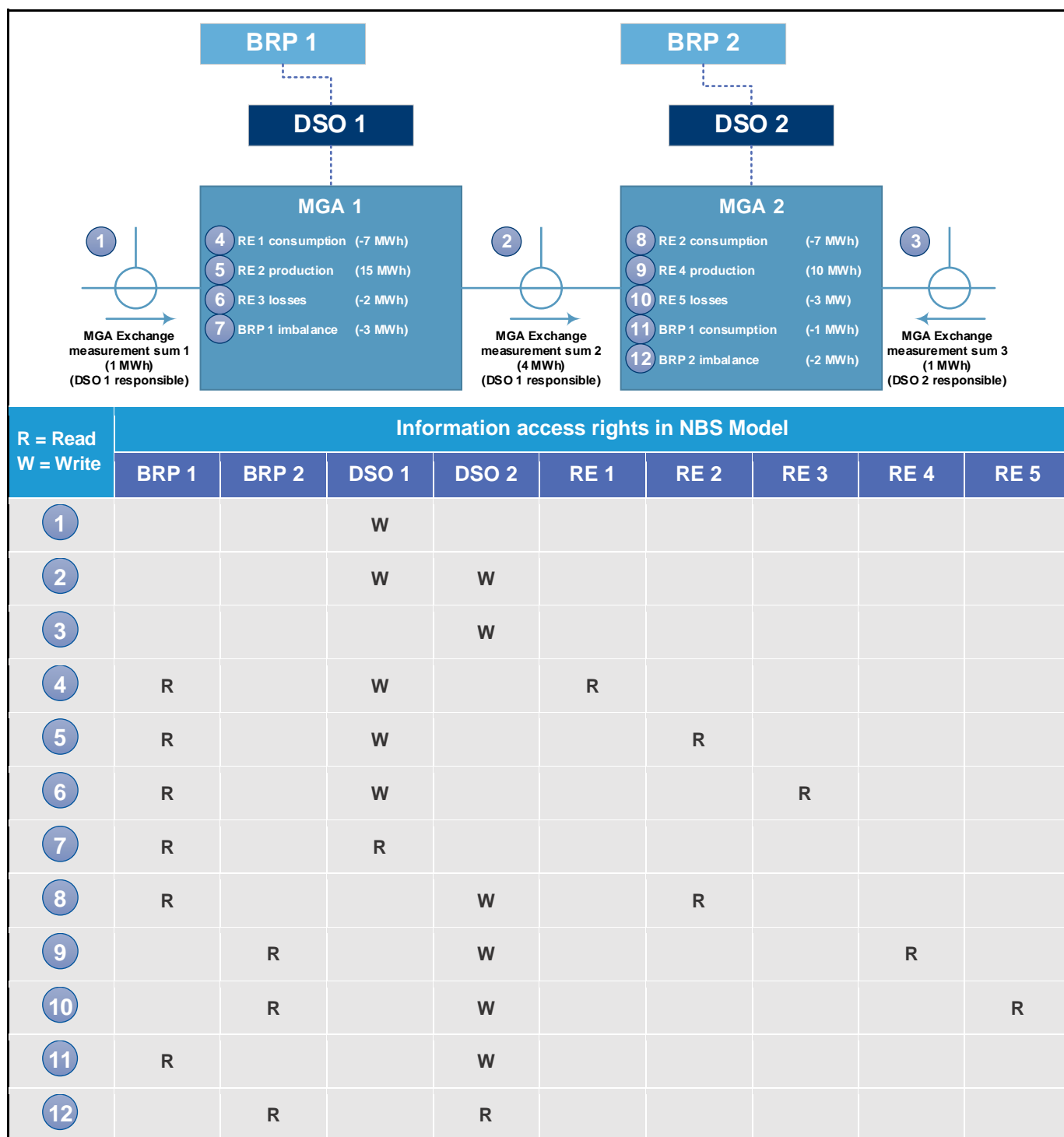

Table 33. Example of information access rights in the NBS model.

10.8 eSett's Reporting

eSett provides both public and restricted reports in accordance with the reporting responsibility. The market participants can also order so called data packages from eSett. The subscriptions are managed through the online service.

Most data packages contain data from D-14 to D-1, where D refers to current day. For some data packages, e.g. imbalance settlement results, there are four different versions of each data package:

- Preliminary (containing data from an open period)

- Final (containing data from a closed period)
- Invoiced (containing data from an invoice period)
- Corrected (with corrections done after invoicing)

Reports available for market participants are statistics report to externals, KPI reports, transparency reports, reports to regulators, financial reports and settlement data packages (presented above).

The reports are either one-time reports or regularly compiled and distributed reports. If the report is compiled and distributed regularly, eSett defines the frequency for that. Some of the reports are not stored in the system after they have been compiled. Report's distribution channel can be; manual retrieval and/or distributed automatically (sent and/or published).

11 Market Behaviour Reporting

This chapter describes how eSett monitors the electricity market and market participants, by collecting settlement information and utilising Key Performance Indicators (KPIs) to follow-up and to enhance the quality of different aspects of the electricity market.

The monitoring of market (and market participant) behaviour is one of the tasks of eSett, for which there are three main objectives; firstly, to monitor that BRPs' imbalances are kept as low as possible, secondly to monitor possible market abuse and thirdly to mitigate the counterparty risk which eSett has towards each of the BRP and BSP.

To perform above tasks eSett collects required settlement information and calculates key performance indicators (KPIs) which evaluate the market performance of different market participants (mainly BRPs and DSOs). After data is collected it is compiled and presented to the public in a transparent and equal way; by publishing a list of public KPIs and company specific KPIs, where market participants can see their KPI ranking in comparison to other market participants and the best performers.

Differences in national practices will be taken into account when analysing the KPIs. For example, the difference between automatic meter reading (AMR) and non-automated metering is taken into account in calculation of the KPIs, depending on the settlement structure.

Regulators, national TSOs and eSett work in collaboration to impose sanctions on BRPs who have systematic imbalances and DSOs who fail to deliver quality data within applied reporting time frames. If the performance is insufficient, eSett takes actions by dialogue with the respective market participant to investigate the reason and seek out possibilities for enhancement. If the dialogue ends in a state where the performance is still found unacceptable, other actions and possible sanctions can be placed for the market participants, for example termination of the imbalance settlement agreement in case of a BRP.

11.1 Monitoring

eSett is responsible for monitoring BRPs' performance. In the monitoring process data is gathered for calculating KPIs and evaluating the BRPs' and DSOs' performance. eSett evaluates the outcome and identifies which market participants are underperforming, misusing their market power or conducting other unprofessional misbehaviour e.g. in the regulating power market.

If KPIs show that, for example, a certain BRP's imbalance is constantly on an insufficient level, eSett can take action to terminate the imbalance settlement agreement of this BRP.

All KPIs are published at the Online Service for BRPs to review and compare their position with other participants on Country level.

11.2 Key Performance Indicators

KPIs are utilised to measure the performance of different market participants. KPIs are a transparent way to display how BRPs carry out their respective responsibilities. eSett will develop KPIs that are critical for TSO to follow up the market behaviour. In addition to these KPIs, eSett will develop in co-operation with Market Participants the KPIs that help the Market Participants to improve their performance and quality.

The following KPIs are presented:

- BRP Imbalance KPI Report – Country
 - Visible only for BRPs who are operating in Norway or Sweden in that specific country
 - Report includes results of all BRPs which are active in that specific country
- BRP Imbalance KPI Report – Own Data
 - Visible for all BRPs
 - Report includes results of BRP's own data
- Advanced Settlement Report – Month
- Advanced Settlement Report – Week
- Production Plan KPI
 - Visible only for BRPs who are operating in Finland, Norway or Sweden
 - Report includes results of BRP's own data

11.2.1 Imbalance Index

Each BRP has physical obligations and rights and has to achieve a planned balance between these (to trade into balance).

Monthly net imbalance should be near zero and thus not show a skewed distribution of positive and negative imbalances. As a result of the analysis the BRPs are classified into three categories – red, yellow and green. Based on the category (see **Table 34**) eSett will notify the BRP for not being in balance and TSO can impose actions towards a specific BRP in analysing the causes for imbalances and in finding the ways to enhance the index (i.e. to minimise imbalance volumes).

In the long run not acceptable	In the short run acceptable	Acceptable
BRPs in this category might be breaching the imbalance settlement agreement. The BRP is urged to improve its balance. A continued classification into this category can result in exclusion from the market.	BRPs in this category are not performing as well as they could regard the imbalances. Although they during the reporting period are not breaching the imbalance settlement agreement a continued classification or worsening imbalance in the future periods can justify a classification as In the long run not acceptable.	BRPs in this category are achieving a good balance. Although the balance is classified as acceptable the BRP can still reduce imbalance costs by improving balance.

Table 34. Imbalance index categories.

11.2.2 Formulas in KPI Reports

Here below are presented all different formulas and threshold values which are used in different KPI reports:

- Imbalance Result formula:

$$\left(\frac{\text{Day-ahead Price} - \text{Imbalance Price}}{\text{Price}} \right) \times \left(\frac{\text{eSett Imbalance Sales Quantity} - \text{eSett Imbalance Purchase Quantity}}{\text{Sales Quantity} - \text{Purchase Quantity}} \right)$$

- Relative Imbalance formula:

$$\frac{\text{Absolute Imbalance Quantity}}{|\text{Consumption}| + |\text{Sales}|}$$

where Sales includes Intraday Trades, Day-ahead Trades and Bilateral Trades per BRP and MBA.

- Imbalance Skewness formula:

IF	$(\text{eSett Imbalance Purchase Quantity} > \text{eSett Imbalance Sales Quantity})$
THEN	$\left(\frac{\text{eSett Imbalance Purchase Quantity}}{\text{eSett Imbalance Sales Quantity}} \right)$
ELSE	$-\left(\frac{\text{eSett Imbalance Sales Quantity}}{\text{eSett Imbalance Purchase Quantity}} \right)$

- Imbalance Skewness for BRP:

Formula for Skewness value	MIN/MAX allowed value from formula	Too skewed?
$\frac{\text{eSett Imbalance Purchase Quantity}}{\text{eSett Imbalance Sales Quantity}}$	2,5 (max)	Yes, BRP has imbalance surplus
$-\frac{\text{eSett Imbalance Sales Quantity}}{\text{eSett Imbalance Purchase Quantity}}$	-2,5 (min)	Yes, BRP has imbalance deficit

- Formulas and threshold values for BRP Imbalance KPI colours:

Measure	Threshold	Country's threshold value			
		Denmark	Finland	Norway	Sweden
Absolute Imbalance	AI – absolute imbalance	1800 MWh	1800 MWh	1800 MWh	1800 MWh
Imbalance Skewness	IS ₁ – 1. Threshold	(-) 1,5	(-) 1,5	(-) 1,5	(-) 1,5
	IS ₂ – 2. Threshold	(-) 2,5	(-) 2,5	(-) 2	(-) 2
	IS ₃ – 3. Threshold	(-) 3	(-) 3	(-) 2,5	(-) 2,5
Relative Imbalance	RI ₁ – 1. Threshold	6 %	6 %	6 %	6 %
	RI ₂ – 2. Threshold	12 %	12 %	10 %	10 %
	RI ₃ – 3. Threshold	15 %	15 %	12,5 %	12,5 %

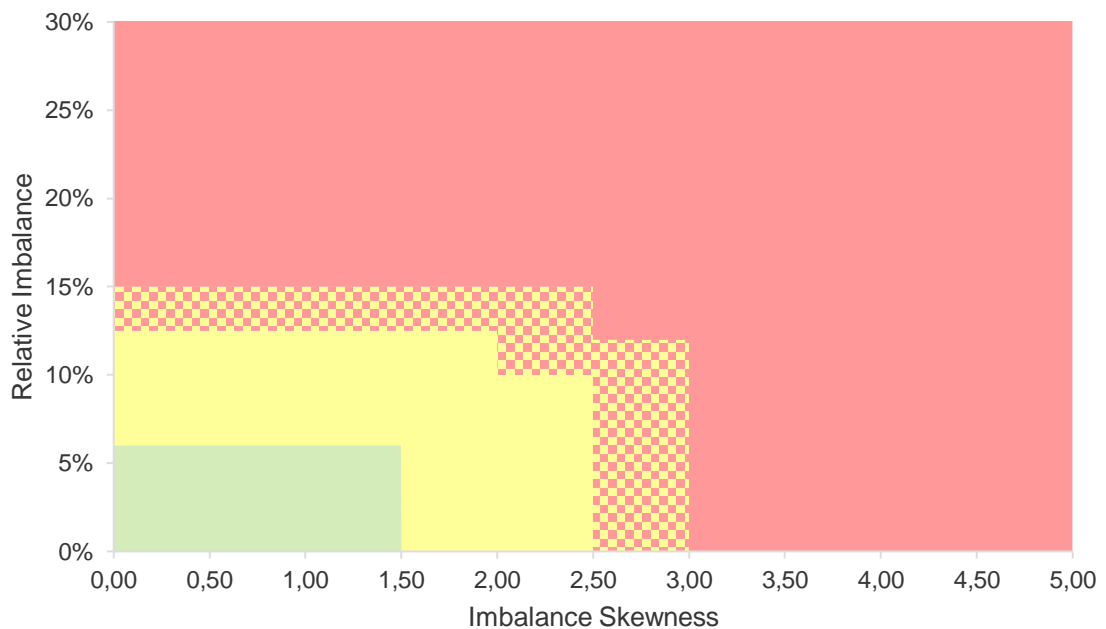
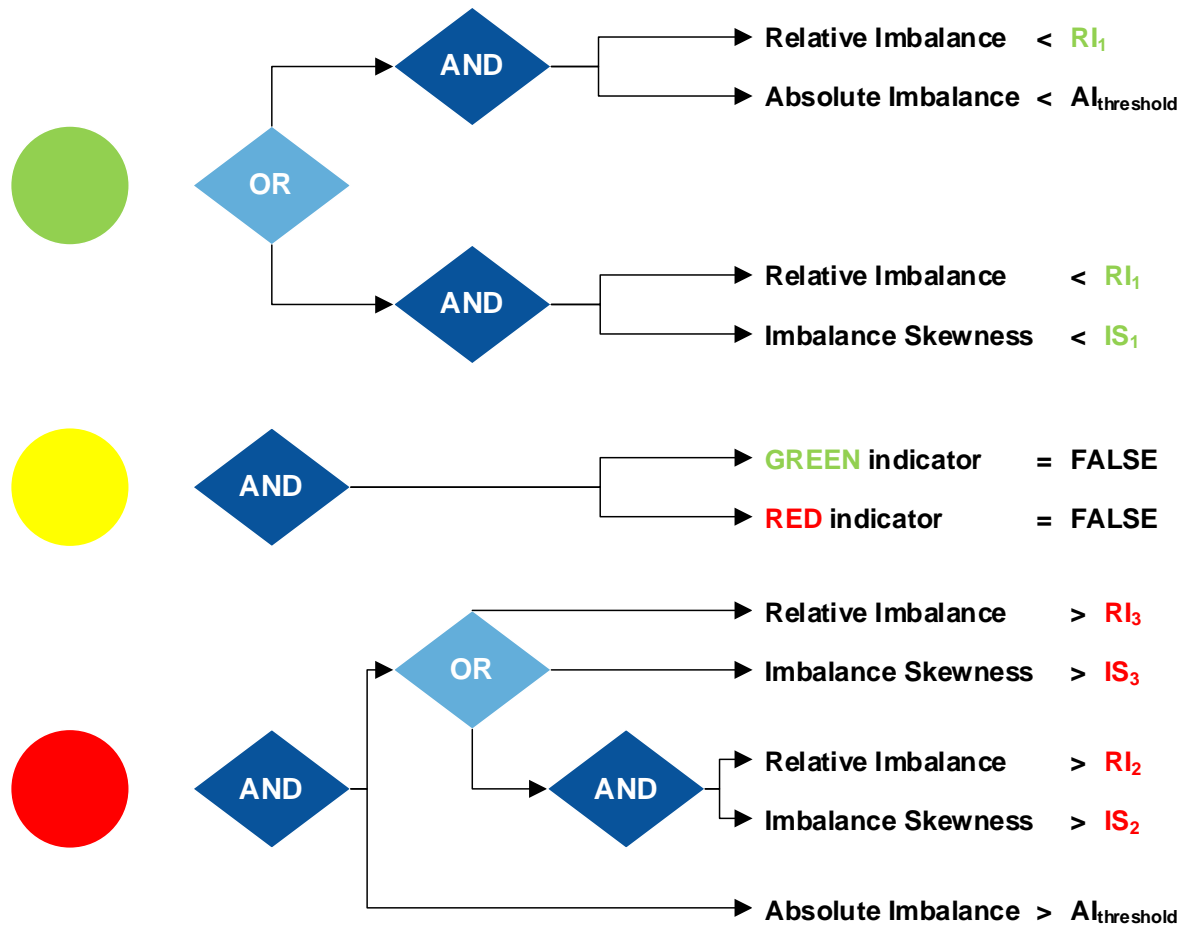













Figure 21. Graphical presentation of BRP Imbalance KPI colours if Absolute Imbalance exceeds the threshold.

- Production Plan KPI formula and threshold values for Production Plan KPI colours:

$$\frac{|\text{Production} - \text{Pumped Storage Consumption} - \text{Production Plan} - \text{Production IA Up} + \text{Production IA Down}|}{\text{Production Plan} + \text{Production IA Up} - \text{Production IA Down}}$$

PU Type	Threshold	Country's threshold value		
		Finland	Norway	Sweden
Hydro	 PP ₁ – 1. Threshold	4 %	2,5 %	2,5 %
	 PP ₂ – 2. Threshold	6 %	6 %	6 %
Nuclear	 PP ₁ – 1. Threshold	1 %	–	2,5 %
	 PP ₂ – 2. Threshold	2 %	–	6 %
Other	 PP ₁ – 1. Threshold	7 %	2,5 %	2,5 %
	 PP ₂ – 2. Threshold	15 %	6 %	6 %
Solar	 PP ₁ – 1. Threshold	18 %	15 %	6 %
	 PP ₂ – 2. Threshold	25 %	25 %	12,5 %
Thermal Power	 PP ₁ – 1. Threshold	3 %	2,5 %	2,5 %
	 PP ₂ – 2. Threshold	6 %	6 %	6 %
Wind	 PP ₁ – 1. Threshold	18 %	15 %	6 %
	 PP ₂ – 2. Threshold	25 %	25 %	12,5 %



Production Plan KPI < PP₁
□

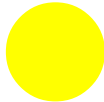

**GREEN Indicator = FALSE
AND
RED Indicator = FALSE**
□



Production Plan KPI > PP₂
□

11.2.3 Advanced Settlement Report

After the settlement period (week or month) has been finalized (final settlement is calculated), there will be created an advanced settlement report for each BRP. The report will summarize the BRP's settlement data and results for the finalized settlement period on a national level and on all the BRP's MBA-levels.

11.2.4 BRP Imbalance KPI Report

The BRPs are obliged to trade into balance, i.e. to minimize their imbalances and to have an even distribution of their imbalances.

Each month after the settlement period has been finalized (final settlement is calculated), the BRP's Imbalance results and the predefined threshold limits are calculated per MBA for the previous month. Then the values are categorized as red, yellow or green, depending on how large and skewed the imbalances are. Report displays last 12 months data for finalized settlement period.

11.2.5 Production Plan KPI

BRPs shall report plans per RO to the TSOs and they are also obliged to keep their plans updated, i.e. report updated values. TSOs also report binding production plans to eSett. The production plans are utilized in a key performance indicator.

As production plan is removed from imbalance calculations, a KPI report is established for monitoring of long-term quality of Production Plans. The report is available for BRPs to have an overview of Production Plan values reported for related Regulation Objects. The KPI report is defined per BRP, MBA and PU Type.

The Production Plan KPI report is not used for Denmark, as production plan values are not reported to eSett.

11.3 Sanctions and Controls

The main objective for BRPs is to stay in balance and keep their imbalances on a minimum level. For a BRP who has systematic imbalances it is possible to impose sanctions and finally terminate the contract. Bad data quality makes it difficult for BRPs to make dependable forecasts, which is why DSOs are being monitored by eSett. However, it is not legally possible for any of the involved TSOs or eSett to impose sanctions on the DSOs. KPIs' calculated by eSett are used by the national regulators to issue economic sanctions for those DSOs which do not live up to predefined minimum levels.

The sanction and control process towards BRPs has three steps:

1. eSett evaluates the BRP performance with the help of the market monitoring data and KPIs
2. If the BRP performance is not at an acceptable level, eSett initiates a dialogue in order to investigate the reason and possibilities to enhance performance
3. TSOs and/or regulators can place sanctions on the BRP
4. If the dialogue ends in a state where the BRP performance is still found too low, the process to terminate the imbalance settlement agreement is started

12 Change Log

Version	Date	Changes
V 0	24.9.2013	Initial version of the Nordic Imbalance Settlement Handbook for Market Participants for reference group review.
V 1	18.3.2014 / 14.04.2014	<p>Updated Terminology.</p> <p>Chapter 1 revised; references to national regulation added.</p> <p>Chapter 2 revised; retailer role and time zone management clarified.</p> <p>Chapter 3 revised; new sub chapters added with more detailed description of settlement structure information.</p> <p>Chapter 4 added; handling of settlement data metering now defined as an own chapter and production metering clarified.</p> <p>Chapter 5 revised; new sub chapters added, adjustments to the existing descriptions made and consumption types clarified.</p> <p>Chapter 6 revised; new sub chapters added, adjustments to the existing descriptions made and figures updated.</p> <p>Chapter 7 revised; new sub chapters added and adjustments to the existing descriptions made.</p> <p>Chapter 8 revised; new sub chapters added, Online Service specified in more details and NBS model's impact on information table added.</p> <p>Chapter 9 revised; new sub chapters added and existing information has been adjusted and updated.</p> <p>Appendix 3 revised; the appendix content on national changes in comparison to NBS model have been clarified.</p>
V 1.1	17.9.2014	<p>The order of chapters Communication and Collateral Management have been changed. Collateral Management is chapter 8 and Communication is chapter 9.</p> <p>Updated Terminology</p> <p>Chapter 1 revised; information about how the market participants will be informed about updated versions of the handbook has been added in 1.2. Figure 2 Relations between eSett and the market participants has been updated.</p> <p>Chapter 2 revised; 2.1 updated with references, 2.2.3 Distribution System Operator updated with country specific information. 2.2.5 Retailer Figure 5 clarified. 2.3 Calendar and Time Zones updated with more details about summer wintertime change. 2.4 Imbalance Responsibility and Agreements updated.</p> <p>Chapter 3 revised; 3.6.7 reporting Schedule and Gate Closure times specified.</p> <p>Chapter 5 revised; 5.1.1 Unit and Accuracy updated, 5.2 Reporting data Flows figures have been updated and a Table 6 that show how eSett reports information and the communication channel has been added. 5.3 Reporting Schedules example to figure 12 has been clarified. 5.4 Reporting Responsibility updated with clarification of delivery day + 1 at 12:00 CET. 5.4.2.1 MGA Exchange Reporting has been updated, 5.6 reporting in Disturbance Situations added.</p> <p>Chapter 6 revised; 6.2 Consumption Imbalance Settlement Figure 16 has been updated. 6.6.3 Step-Wise Approach in Norway clarified, 6.7 Imbalance Settlement in Disturbance Situations added.</p> <p>Chapter 7 revised; clarified and restructured.</p> <p>Chapter 9 Communication, 9.1 Data Communication Standards has been updated.</p> <p>Appendix 4 Structure Elements per Responsible Market Participant has been updated.</p> <p>Appendix 5 Nordic Calendar added.</p>
V2.0	8.12.2014	<p>The name has been updated to Nordic Imbalance Settlement Handbook, Instructions and Rules for Market Participants and the status is For implementation</p> <p>Foreword; revised</p> <p>Terminology; BRP, DSO and TSO updated</p>

Version	Date	Changes
		<p>Chapter 1 revised; The market participants will be informed about handbook updates on the web site and by newsletters.</p> <p>Chapter 2 revised; 2.2.1 Imbalance Settlement Responsible (eSett) revised. 2.2.3 Distribution System Operator has been updated. 2.2.6 Market Operator (Nord Pool Spot): "Informing eSett if any market participant is misusing the market or behaving abnormally" added. 2.4.1 Imbalance Settlement Agreement: topics included in the imbalance settlement agreement list revised. 2.4.2 Entering into Agreement has been updated.</p> <p>Chapter 3 revised; the introduction has been updated and a table with structure report MGA examples has been added. 3.1 Settlement structure: a figure with an illustrative example of structure elements and their relations has been added. 3.6.7 Reporting Schedule and Gate Closure Times: an example of the gate closure times for reporting structure information has been added.</p> <p>Chapter 4 revised; 4.1 Metered Data by Types: the calculation of losses in Finland has been clarified.</p> <p>Chapter 5 revised; 5.2 Reporting Data Flows: figure 10 and 11 have been updated, a table with information types has been added. 5.4.2.2 Example of MGA Exchange Reporting has been added. 5.4.2.4 Reporting of Consumption Sweden: calculation of metered losses has been added.</p> <p>Chapter 6 revised; 6.4 Imbalance Settlement with Missing Data has been added</p> <p>Chapter 7 Pricing and Fees has been added.</p> <p>Chapter 8 Invoicing has been rewritten.</p> <p>Chapter 9 Collateral and Risk Management has been rewritten.</p> <p>Chapter 10 revised; 10.1.1 The Communication Coding Schemes for the Market Participants has been updated</p> <p>Appendix 1 revised.</p>
V2.01	17.12.2014	Terminology; MEC: MP's metered consumption in MGA or MP's production plan per PU rectified to per RO.
V2.1	24.04.2015 / 19.5.2015	<p>Foreword; revised</p> <p>Terminology; BRP, DSO, TSO and MBA updated</p> <p>Chapter 1; Customer Committee will be established, process for updating the handbook has been rewritten</p> <p>Chapter 2; revised; 2.2.3 updated with DSO role in Norway</p> <p>Chapter 3; chapter revised and restructured; figure 7, table 2, 3, 4 and 6 updated; new table 7 added with TSO gate closures</p> <p>Chapter 4; revised; 4.1, new consumption type PU own consumption added; 4.4.3 reporting of minor production in Finland clarified;</p> <p>Chapter 5; revised; reporting of bilateral trades in Sweden clarified; 5.1; updated with governance of reporting requirements; 5.2, Figure 11 and 12 updated; 5.3 updated</p> <p>Chapter 6; revised; 6.5, handling of balance errors after gate closure will be handled according to national procedures</p> <p>Chapter 8; revision of required banking setup</p> <p>Chapter 9; revision of collateral schedule, clarification of collateral formula</p> <p>Chapter 10; revised, 10.1.1 Data Communication encryption added</p> <p>Appendix 1; Registration as liable to energy tax in Sweden added</p> <p>Appendix 2; removed</p> <p>Appendix 4; removed</p> <p>Chapter 5.1.1. Unit and Accuracy. Requirements related to Finland clarified.</p>
V2.11	03.07.2015	<p>Terminology; Definition of Regulation Object updated</p> <p>Foreword; reference to the Communication guidelines added</p> <p>Chapter 3; Table 3 updated regarding RO and PU</p> <p>Chapter 5; Introduction: Updated how reporting is regulated in Norway.</p> <p>Chapter 5.2; figure 11 updated with clarification regarding confirmation reports; figure 12 updated with clarification regarding PPC</p> <p>Chapter 5.3; Updated reporting schedule for Norway</p>

Version	Date	Changes
		<p>Chapter 7.3; Revised and updated</p> <p>Chapter 9.3.1; explanation of terms S_1 and S_2 of the standard formula adjusted</p> <p>Chapter 10; Revised and updated ;10.1 Messaging service added;10.1.1 Data packages added, 10.2 Data Communication Standard updated</p> <p>Appendix 2; revised and updated</p>
v.2.12	07.10.2015	<p>Chapter 2.3 Revised and updated with Finnish and Swedish time zones for structure management</p> <p>Chapter 3.5.4 Revised</p> <p>Chapter 5.3 Revised and updated</p> <p>Chapter 5.4.1 Chapter updated with change of 2nd gate closure</p> <p>Chapter 5.4.2.3 Chapter Revised</p>
v.2.13	11.03.2016	<p>General changes; Connection guideline name changed to Communication guidelines; Nord Pool Spot name changed to Nord Pool</p> <p>Foreword; Added document information on Acknowledgements UserGuide with link</p> <p>3.2 Changes in introduction</p> <p>Terminology; the term Market Operator updated</p> <p>Chapter 2.2.6 Market Operator; added that MO conducts market surveillance and reports any suspected breach of applicable regulations by the market participants to the national regulators</p> <p>Chapter 2.2.7 Service Provider added</p> <p>Chapter 2.5 Company data model defined and this new chapter added</p> <p>Chapter 3.2.1 added Unbundling Rules; Company-Market Participant role structure relation defined and explained how unbundling rules impact each country.</p> <p>Chapter 3.2 Market Participants; defined that a company might have multiple market participants of the same role</p> <p>Chapter 3.5.5 MO; Term Market Operator used instead of Nord Pool</p> <p>Chapter 3.5.7 Reporting Schedule and Gate Closure Times; tables Gate closure times for reporting structure information and TSO gate closure times for reporting structure information defined that full days shall be used for structure gate closure times.</p> <p>Chapter 4.1 Metered Data by Types; defined that PU Own consumption type can be used for hourly profiled consumption in Finland</p> <p>Chapter 5.1.3 Status of Reported Values; statuses defined more detailed level</p> <p>Chapter 5.2 Reporting Data Flows; missing arrow Confirmation of the MGA exchanges updated to the figure Reporting after the delivery hour (1-13 days); table Information types updated</p> <p>Chapter 5.3 Reporting Schedules; updated that Based on the Finnish legislation the DSOs in Finland are able to report delivery day settlement data in EET/EEST until the 12 day at 00:00 EE(S)T after the delivery day</p> <p>Chapter 5.4.3.1 eSett Reporting or Publishing to BRP; aggregations to BRP updated based on the generic data packages</p> <p>Chapter 5.4.4.1 Reporting of PX Market Trades; updated that Day-ahead and Intraday trades will be reported on RE-level</p> <p>Chapter 8.4 Required Banking Setup; updated that The settlement account will be updated by the BRP through Online Service; more information about MT101 and MT940 –agreements updated to the respective chapter</p> <p>Chapter 9.3.1 Standard Formula; Minimum collateral requirement 40 000 € per country updated</p> <p>Chapter 9.8 Release of Collateral; the procedure defined how BRP shall inform eSett of the account that shall be used for releasing the excess collateral</p> <p>Chapter 9.9 Monitoring of Settlement Banks; updated the requirements that a bank must fulfill in order to be approved as a settlement bank for the imbalance settlement</p> <p>10.1.1 Data Packages; the Specific and the Generic data packages presented, pictures added</p> <p>10.1.4 The Communication Coding Schemes for the Market Participants; explained that for messaging and data exchange purposes a coding scheme and market</p>

Version	Date	Changes
		<p>participant code will be determined for each market participant role. The national practices for coding scheme and MP's codes presented.</p> <p>10.2. Information Services; added the table that presents what data can be requested via Information Service</p> <p>Appendix 3 Nordic calendar updated for the year 2016</p>
v.2.2	21.11.2016	<p>General changes; Market Operator changed to Nominated Electricity Market Operator, Elspot and Elbas changed to Day-ahead and Intraday</p> <p>Foreword; chapter revised</p> <p>Terminology; Market Balance Area and Market Operator changed</p> <p>Chapter 1 Introduction; revised; 1.6.2 and 1.6.3; updated links to laws and regulations</p> <p>Chapter 2; revised; 2.2.6 Updated to NEMO; 2.3 clarification of settlement structure in Sweden related to Time Zone</p> <p>Chapter 3.2.1 Unbundling rules; clarification for Norwegian companies.</p> <p>Chapter 3.4 Market Entity Connection; PX Market Trade and PX market Flows updated</p> <p>Chapter 5 Settlement Data Reporting; revised; 5.4.2.3 Reporting of production; Clarifying text regarding reporting of production below 1 MW</p> <p>Chapter 6 Imbalance Settlement; revised; Figure 16 and 17 updated</p> <p>Chapter 7 Pricing and Fees; revised</p> <p>Chapter 10 Communication; revised and restructured; 10.1; updated with interface used for sending structural information to eSett; 10.2 updated with interface used for receiving structural information from eSett</p> <p>Chapter 11 Market Behaviour Reporting; revised</p> <p>Appendix 3 Nordic calendar updated for the year 2017</p>
v.2.21	27.4.2017	<p>Chapter 3.5.7 Reporting Schedule and Gate Closure Times; Gate closure times for structures updated (Table 6. Gate closure times for reporting structure information).</p> <p>Chapter 5.4.4 NEMO; Reporting schedules for Nominated Electricity Market Operator specified in more detailed level.</p>
v.2.22	27.11.2017	<p>Bilateral trade reporting change in accordance of the NBS-model in Sweden after 26.9.2017 00:00 SNT. Bilateral trade reporting on retailer level and directly to eSett. Changes for the following parts of the Handbook:</p> <p>Table 6. Gate closure times for reporting structure information</p> <p>Figure 11. Reporting per delivery hour</p> <p>Chapter 5.4.1.3 Bilateral Trade Reporting</p>
v.2.23	15.3.2018	<p>Terminology: Change in the explanation for RE</p> <p>Nord Pool, Elspot and Elbas replaced by NEMO, day-ahead and intraday</p> <p>Chapter 3.5.7: Changes to gate closures for structures</p> <p>Chapter 5.3: Added information about Swedish gate closures for reporting</p> <p>Chapter 5.4.1.3 Bilateral Trade Reporting</p> <p>Chapter 10.4.1: Information about encryption for Swedish messages</p> <p>Chapter 11.2.1 Imbalance Index removed text.</p>
v.2.3	23.11.2018	<p>Foreword removed, and the relevant information added to the introduction chapter.</p> <p>Table and Figure numbering updated.</p> <p>Terminology updated and a new term "Metered Data Aggregator" added.</p> <p>Chapter 1 Updates, clarifications and removal of obsolete information.</p> <p>Chapter 2.1 Clarified the differences of Metering and Reporting.</p> <p>Chapter 2.2.2 Minor correction: "prices" → "volumes".</p> <p>Chapter 2.2.8 Metered Data Aggregator added.</p> <p>Chapter 3.5.4 Added information regarding Elhub.</p>

Version	Date	Changes
		<p>Chapter 3.5.5 Metered Data Aggregator added.</p> <p>Chapter 3.5.8 Updated new gate closures to Table 5. New GCs allow some changes 7 days back in time.</p> <p>Chapter 4 Introduction clarified and added information regarding Elhub.</p> <p>Chapter 5.3 Updated Figures 10-12.</p> <p>Chapter 5.4.x Tables 10-13 and their explanations updated and clarified.</p> <p>Chapter 6.2 Updated Figure 16.</p> <p>Chapter 6.2.1 Replaced DSO with Metered Data Aggregator.</p> <p>Chapter 9.3.1 Intra-day trades included in the collateral formula.</p> <p>Chapter 10.1 Text updated.</p> <p>Chapter 10.5.1 Text updated.</p> <p>Chapter 11.1 Updated Monitoring information.</p> <p>Chapter 11.2 Updated information about KPI Reports.</p> <p>Chapter 11.2.2 Information about formulas in KPI Reports.</p> <p>Chapter 11.2.3 Advanced Settlement Report introduction.</p> <p>Chapter 11.2.4 BRP Imbalance KPI Report introduction.</p> <p>Appendix 2 removed.</p> <p>Appendix 3 renamed -> Appendix 2.</p> <p>Appendix 2 Nordic Calendar updated.</p> <p>Contact information on the last page updated.</p>
v.2.3.1	3.5.2019	<p>Chapter 2.1 Bullets about outgoing reporting and communication combined.</p> <p>Chapter 3.5.8 Updated the gate closure times for changes in Norway as a new longer reporting period is applied for Elhub. Added missing gate closure for MGA-DSO relation.</p> <p>Chapter 5.3 Updated that Elhub handles the reporting towards eSett instead of DSOs in Norway.</p> <p>Chapter 5.4.2.3 Clarification on reporting of production.</p> <p>Chapter 6.4 Minor clarification on how the missing settlement data can be viewed in Online Service.</p> <p>Chapter 6.7.3 Elhub handles reconciliation in Norway.</p> <p>Chapter 11.2.2 Relative Consumption Imbalance formula updated.</p>
v.2.3.2	12.12.2019	<p>Included the Bilateral trade reporting between NEMOs into the reporting responsibilities to Table 11 and chapters 2.2.6, 3.5.6, 5.4.4.1 and 5.4.4.3.</p> <p>Chapter 5.4.2.1 Clarification on reporting schedules on a situation where the MGAs of an MGA exchange are located in different countries.</p> <p>Appendix 1. Removed -> Registration as liable to energy tax in Sweden.</p> <p>Responsibility moved from BRP to DSO 1.1.2018</p> <p>Appendix 2 Nordic Calendar updated for year 2020.</p>
v.2.4	23.4.2020	<p>General changes: In preparation of Denmark joining to the NBS model, all relevant information about Danish market has been included into NBS Handbook. Thus, several chapters, tables and figures also include information regarding Denmark.</p> <p>This includes updates to e.g. Danish regulations, unbundling, metering, reporting, reconciliation, VAT handling and coding scheme requirements.</p> <p>Chapter 1 Introduction on how Denmark will join NBS model in two phases added to Handbook.</p> <p>Chapter 2.2.6 NEMO may delegate its tasks related to balance responsibility to the CCP of the NEMO.</p> <p>Chapter 3.4 New Market Entity Connection, Merged Production, has been added.</p> <p>Chapter 3.5.3 Corrected the description on how bilateral trades are managed by BRPs.</p> <p>Chapter 3.5.6 If NEMO has delegated its tasks to a CCP, the CCP will be the one carrying out all the responsibilities of the NEMO.</p>

Version	Date	Changes
		<p>Chapter 3.5.8 Updated gate closure information for Retailer Balance Responsibility (RBR) changes; five days is applied for all RBR changes except for terminations.</p> <p>Chapter 4.1 New consumption measurement type “flex-settled” added. Currently, only used in Denmark.</p> <p>Chapter 5 New data flow between TSO and eSett, ‘Contracted reserves’ (only in Denmark).</p> <p>Chapter 5.4.3 Corrections and clarifications to what eSett publishes and where.</p> <p>Chapter 5.4.4.2 Updated the section of how PX market price is generated.</p> <p>Chapter 6 Imbalance settlement calculation figure updated, so that there’s now ‘± MGA imbalance’ which more accurately presents how it’s used in calculations.</p> <p>Chapter 8.1 Purchased contracted reserves included into invoice example (only used in Denmark).</p> <p>Chapter 9 Added information that BRPs that are active only in the Danish market will not be asked to deposit collateral towards eSett.</p> <p>Chapter 9.9 Bank rating requirements for settlement banks are updated.</p> <p>Chapter 10.1 New channel, ECP/EDX is included.</p> <p>Chapter 10.2 New data packages listed.</p> <p>Chapter 10.4.2 New chapter about data encryption in ECP/EDX channel.</p>
v.2.5	4.9.2020	Updated gate closure timings for Production Unit and Consumption structure changes in Sweden in chapter 3.5.8. Starting from 1.9.2020 structures may be created and updated up to 10 days back in time in Sweden.
v.2.6	7.12.2020	<p>New chapter, 4.6 Energy Storages, to describe the handling of energy storages in NBS model and the national differences that apply.</p> <p>Chapter 2.5 Updated the number of required Balancing Agreements to two for the example #3 (i.e. 1 per country).</p> <p>Chapter 3.5.8 Updated gate closure time for MGA Exchange MECs from 14 days to 7 full days before the delivery day.</p> <p>Chapter 5.4.2.4 Deleted obsolete sentence about eSett being responsible for providing the settlement data used for issuing Guarantees of Origin and electricity certificates in Norway.</p> <p>Clarified the handling of negative interest rates in Pledged Cash Accounts to chapters 8.5 Invoicing Schedule and 9.8 Release of Collateral.</p> <p>Chapter 10 Updated FTP to SFTP.</p> <p>Table numbering updated due to a new table in chapter 4.6 Energy Storages.</p> <p>Appendix 2 Updated Nordic Calendar for year 2021.</p>
v.2.7	15.4.2021	<p>New chapter, 2.4.3 Termination of Agreement, which describes the processes in such case and handling of retailers in each country.</p> <p>Clarified the requirements regarding the use of market participant codes in chapter 10.4.3 The Communication Coding Schemes for the Market Participants.</p> <p>Updated the list of available public data to chapter 10.5.1 Public Part.</p> <p>Harmonization of chapter 10.5.3 Online Service User Account with the Online Service’s Terms of Use.</p>
v.3.0 (draft for Single Balance Model)	17.5.2021	<p>This version update takes handbook up-to-date with the single balance model and higher time resolution imbalance settlement.</p> <p>Terminology: New term “Imbalance Settlement Period”, ISP.</p> <p>Consumption and Production imbalances replaced by single imbalance throughout the handbook.</p> <p>Removed or replaced references to hourly imbalance settlement period throughout the handbook.</p> <p>Table and Figure numbering updated, since some of them have been removed.</p>
v.3.1	1.10.2021	Terminology updated to better match and refer to the terms used in EBGL. Updated terms: ‘imbalance’, ‘MBA’ and ‘PU’,

Version	Date	Changes
		<p>New terms added: 'balancing service', 'balancing energy', 'incentivizing component' and 'Value of Avoided Activation'.</p> <p>Minor corrections throughout handbook to sections that were not correctly updated in version 3.0.</p> <p>Chapter 1.4 Regulation updated with a reference to the EU guideline on electricity balancing.</p> <p>Chapter 4.4.3 Clarification for special cases in Finland.</p> <p>Chapter 5.4.3.1 Production Plans restored to the list.</p> <p>Chapter 7 Clarifications and corrections to the use of VoAA, IC and day-ahead market price.</p> <p>Chapter 8.1 Invoice contents example restructured to reflect the PDF invoices more accurately.</p> <p>Chapter 8.2 E-invoice format used by eSett updated from Finvoice 1.3 to 3.0.</p> <p>Chapter 10.2 Added new data packages for North Sea Link (NSL) related trades and flows.</p>
v.3.2	1.11.2021	<p>New chapter 5.4.5.5 of TSO reporting binding intraday and day-ahead flows.</p> <p>Chapter 5.4.5.3 Production plan values are not reported to eSett in Denmark.</p> <p>Chapter 11.2 National production plan KPI threshold values added.</p>
v.3.3	26.1.2021	<p>A new banking setup, Cash Account model, is introduced in chapter 8.4, and it also has some minor impacts on chapters 8.5, 9.2, 9.6 and 9.8.</p> <p>Terminology: Updated definition for the Incentivizing Component (IC).</p> <p>Chapter 3.5: The capacity that DSO or Metered Data Aggregator needs to update for the PU, represents the nominal capacity of the unit.</p> <p>Chapter 7.2.1: New table to clarify the formation of Volume Fee per country.</p> <p>Chapter 10.4.3: Corrected the wording for the use of GLN codes for different roles in Finland.</p> <p>Chapter 11.2.2: A pumped storage consumption included into the Production Plan KPI formula.</p> <p>Nordic Calendar updated.</p>
v.3.4	2.5.2022	Data Retention Policy included into Chapter 10 Communication.
v.4.0 (draft for BSP Model)	31.1.2021	<p>The document template updated.</p> <p>This version updates the handbook into BSP model compatible by separating the BRP and BSP roles and presenting the related changes throughout the handbook. Major changes are listed below:</p> <p>Terminology: A new market role, BSP, introduced.</p> <p>Chapter 2.2.5; BSP role and its responsibilities and requirements.</p> <p>Chapter 3.5.4: BSP's responsibilities regarding structure information.</p> <p>Chapter 5.2: Updated data flow reporting figures and information table with BSP included.</p> <p>Chapter 5.4.1: Removed regulation bid reporting from the BRP.</p> <p>Chapter 5.4.3: Included BSP as a counterpart for eSett's reporting and publishing.</p> <p>Chapters 6.2 and 7.3: Updated imbalance and invoice calculation examples with BSP in consideration.</p> <p>Chapter 8.1: BSP invoice contents included and BRP invoice contents updated.</p> <p>Chapter 8.2: Explanation of invoice handling for companies with both BRP and BSP roles.</p> <p>Chapter 9.11: Collateral management of BSPs.</p> <p>Chapter 10.5.2: Online Service features table updated with BSP.</p>
v.4.1	10.10.2022	<p>Status updated: "For contractual basis".</p> <p>Terminology: A footnote added to clarify the application of 15 min ISP in different countries.</p>

Version	Date	Changes
		<p>Chapters 2.2.4 and 2.2.5: Clarification of roles, responsibilities and requirements of both BRP and BSP in a case where a BRP has a valid agreement with a TSO regarding balancing services.</p> <p>Chapter 7.2.2: Explanation of “Hourly netted imbalance fee” option of TSOs added.</p> <p>Chapter 8.1: Removed obsolete products from the invoice example for reconciled energy of BRPs in Sweden.</p> <p>Appendix 1: Removed an outdated part regarding the settlement account, to align it with chapter 8.4 and the earlier update of a banking setup.</p>
v.4.2	1.12.2022	<p>Terminology: Term for BSP updated to Balancing Service Provider.</p> <p>Chapter 2.2.4: Updated that planning of balanced schedules is per ISP.</p> <p>Chapters 4.2 and 5.1.1: New Finnish Energy’s direction document “Principles of electricity metering 2022” replaces the old one “Tuntimittauksen periaatteita 2016”.</p> <p>Chapter 5.4.1: Updated that new gate closure for Bilateral Trade reporting in Finland (1st GC) will be 0 minutes from 22.5.2023 01:00 EEST.</p> <p>Chapter 8.6: Updated that if the collateral requirement updates during the invoicing day isn’t published by 13 CET, the additional collateral doesn’t have to be placed on a same day.</p> <p>Chapter 8.7: Added a paragraph about temporary reduction of VAT rate for electricity in Finland during 1.12.2022-30.4.2023.</p> <p>Nordic Calendar updated.</p>
v.4.3	19.4.2023	<p>Chapter 3.5.9: Corrected the time schedule in the second example scenario where retailer is already valid in and only needs new retailer balance responsibility relations.</p> <p>Chapter 5.1.1: Corrected the reporting accuracy in Finland from the previous 10 Wh to 1 Wh.</p> <p>Chapter 5.4.4.2: Small clarification to the text about calculation and publishing of day-ahead area prices.</p> <p>Chapter 11.2.2: New graphical illustration of BRP Imbalance KPI formulas and limits.</p>
v.4.4	28.6.2023	<p>Updated that settlement banks and accounts may be within European Economic Area instead of only Denmark, Finland, Norway and Sweden. Chapter 8.4 and Appendix 1 updated to reflect that information.</p>
v.4.5	1.10.2023	<p>Several minor updates regarding settlement and invoicing of balancing capacity in Sweden.</p> <p>Several updates regarding the profiled consumption settlement processes in Sweden as the calculation of profiled consumption and settlement of reconciliation transitions from Svenska kraftnät to eSett from delivery day 1.11.2023.</p> <p>Chapter 1.4: Added link for national terms and conditions for BSP in Finland. Updated latest secondary regulation for Sweden.</p> <p>Chapter 2.4: Balancing Service Settlement Agreement included into the chapter.</p> <p>Chapter 3.5.9: MGA gate closure timing and prerequisites and remarks added.</p> <p>Chapter 8: Minor clarifications regarding BSPs.</p> <p>Chapter 9.3.1: Standard collateral formula’s P component updated. Negative prices are handled as zero prices starting from 2.10.2023.</p> <p>Chapter 10.5: Open Data (previously ‘public part of Online Service’) separated to it’s own chapter and updated.</p> <p>Chapter 10.6.1: User management updated – inactive users may be removed by eSett.</p> <p>Chapter 11.2: Imbalance factor and skewness shall be combined into a single measure “Imbalance skewness” that provides better comparability for positive and negative skewness.</p> <p>Nordic Calendar updated.</p> <p>New appendix 3: Reconciliation model for Sweden in eSett.</p>

Version	Date	Changes
v.4.6	1.1.2024	<p>Table 8 Information types updated, as invoices for the reconciled energy for the BRPs in Sweden will be available in the Online Service starting from the delivery month November 2023.</p> <p>Chapter 8.4: Removed one obsolete sentence.</p> <p>Chapter 8.6: Addition that exception in invoicing schedule also causes the reconciliation invoicing schedule to move forward correspondingly if applicable.</p> <p>Chapter 10.6.1.2: User inactivation time after password has expired extended to four (4) months from previous two (2) months.</p> <p>Appendix 3: Reconciliation invoicing clarified, so that there is deadline of 13 CET for publishing of the invoices. Also, an NBS holiday on Monday also moves the reconciliation invoicing by one day, so that imbalance settlement invoicing won't occur on a same day as reconciliation invoicing.</p>
v.4.7	4.4.2024	<p>Terminology: Imbalance Settlement Period (ISP) updated and old reference to hourly ISP removed. Also, a footnote about the 15-minute ISP updated, since the metered data in Sweden and Norway is now reported in 15 min to eSett.</p> <p>Chapter 2: Added some clarifications regarding the BSP, its responsibilities and agreements, mainly that there is no need for a separate Balancing Service Settlement Agreement, if the BSP already has a valid Imbalance Settlement agreement with the same business entity.</p> <p>Chapter 3.3: Production under 1 MW in Sweden has now the type "minor" instead of "normal".</p> <p>Chapters 3.5.5 and 3.5.6: Merged production separated more clearly into its own reporting in the responsibilities.</p> <p>Chapter 3.5.9: Merged production added into the table about gate closures for reporting.</p> <p>Chapter 5.4.2.3: Updated the information regarding Sweden, after production < 1 MW is reported as a merged production.</p> <p>Chapter 5.4.4.1: Intraday Auctions included into the text.</p> <p>Chapters 7 and 7.1: Updated description about the price components and pricing of imbalance for cases where TSO has joined PICASSO, and volume-weighted aFRR energy price becomes a price component.</p> <p>Chapter 7.2.1: Minor production is part of the volume fee calculation in Sweden.</p> <p>Chapter 10.2: New specific data package 'FRR-A volume-weighted average price per Market Balance Area (MBA)'.</p> <p>Appendix 3: Added a strong recommendation that DSOs would report initial Final Loadshares latest on the 15th of the second month after delivery.</p>
v.4.8	1.9.2024	<p>Chapter 8.4: Clarifications to the required banking setup and precondition regarding being entitled to access the electricity market settlement.</p> <p>Chapter 8.7: Updated the new VAT rate of 25,5 % for Finland which is valid from 1.9.2024.</p> <p>Chapter 9.6: Added a clarification that new collateral demands are not published on NBS holidays.</p> <p>Chapter 9.8: Added a clarification that requests to release excess funds are not processed on NBS holidays.</p>

Appendices

- Appendix 1 Requirements on Becoming a Balance Responsible Party
- Appendix 2 Nordic Calendar
- Appendix 3 Swedish Profiling and Reconciliation

Appendix 1 Requirements on Becoming a Balance Responsible Party

This Appendix specifies the requirements that a company applying for a role as a BRP must fulfil in order to be allowed to start operating as a Balance Responsible Party.

Submission of Information about the Applying Company

The applicant shall submit to eSett in electronic format the following information:

- Name of the company
- Visiting and postal address
- Trade registry number
- Copy of valid documentation (e.g. passport) in order to verify signature(s)
- Copy of trading concession from the Norwegian water resources and energy directorate (NVE), in case the BRP is applying for participation in the Norwegian electricity wholesale market
- VAT number(s) applicable in the country(ies) where the BRP intends to participate in the electricity wholesale market
- Any additional information that eSett may reasonably request for the purpose of identifying the company
- 24-hour contact information for Fingrid Oyj
- Contact information of persons in charge of
 - The balance service agreement
 - Guarantees
 - Balance settlement
 - Data exchange and reporting
 - Invoice processing
- Invoicing details as follows:
 - If the BRP wishes to receive e-invoices: BRP's e-invoice address and ID of the BRP's e-invoice operator
 - If the BRP does not wish to receive e-invoices: email address to which invoices will be sent as PDF files
- Banking details including
 - Name, Bank Identification Code (BIC) and contact details of the BRP's Settlement Bank, as defined in Chapter 8.3
 - International Bank Account Number (IBAN) of the BRP's Settlement Account, as defined in Chapter 8.3
- Financial information
 - Financial statements from the two latest fiscal years
 - Any additional information that eSett may reasonably request for the purpose of assessing the company's financial stability

Opening of a Settlement Account

The applicant shall open a bank account ("Settlement Account") in a bank, which has been approved by eSett to be used in the Imbalance Settlement ("Settlement Bank") as described in Chapter 8.4. The Settlement Account must be held in European Economic Area (EEA). The BRP shall also enter into any necessary agreements with its Settlement Bank to enable the settlement of payments in accordance with the procedures and schedules specified in chapter 8, such as any possibly required agreements on same-day-value payments. The Settlement Bank will advise on what agreements are required.

Posting of Collateral

The applicant shall post collateral in its Settlement Bank in accordance with the requirements defined in Appendix 2 of the Imbalance Settlement Agreement. eSett will perform a risk assessment of the applicant to determine the initial amount of collateral required from the applicant. The minimum amount of collateral for a new BRP is 40,000 EUR per country, except in Denmark where Danish TSO Energinet carries out the counterparty risk. The required initial collateral amount must be deposited before any trades can be performed.

Testing of Data Communication

The applicant shall test its data communication capabilities in accordance with instructions provided by eSett.

Signing of Agreements

To become a BRP, the applicant shall enter into an Imbalance Settlement Agreement with eSett. This agreement shall be signed between eSett and the applicant and must remain valid during the whole period of operation as a BRP. eSett will inform the applicant when the Imbalance Settlement Agreement can be entered into. The applicant then signs the agreement after which eSett will enter the date of activating the applicant as BRP into the imbalance settlement system.

In addition to the Imbalance Settlement Agreement with eSett, the applicant shall sign a Balance Agreement with the TSO in each of the countries where the applicant is going to operate. The Balance Agreement(s) constitute Appendices to the Imbalance Settlement Agreement. The Balance Agreement(s) must remain valid during the whole period of operation as a BRP.

Appendix 2 Nordic Calendar

Nordic Calendar			
Month	Date	Holiday	Country
January	1.1.2024	New Year's Day	Denmark, Finland, Norway, Sweden
	6.1.2024 (sat)	Epiphany	Finland, Sweden
March	28.3.2024	Maundy Thursday	Denmark, Norway
	29.3.2024	Good Friday	Denmark, Finland, Norway, Sweden
April	1.4.2024	Easter Monday	Denmark, Finland, Norway, Sweden
May	1.5.2024	Labour Day	Finland, Norway, Sweden
	9.5.2024	Ascension Day	Denmark, Finland, Norway, Sweden
	10.5.2024	Bank holiday	Denmark
	17.5.2024	Constitution Day	Norway
	20.5.2024	Whit Monday	Denmark, Norway
June	5.6.2024	Constitution Day	Denmark
	6.6.2024	National Day	Sweden
	21.6.2024	Midsummer Eve	Finland, Sweden
November	1.11.2024	Friday before All Hallows' Day	Sweden
December	6.12.2024	Independence Day	Finland
	24.12.2024	Christmas Eve	Denmark, Finland, Norway, Sweden
	25.12.2024	Christmas Day	Denmark, Finland, Norway, Sweden
	26.12.2024	Boxing Day	Denmark, Finland, Norway, Sweden
	31.12.2024	New Year's Eve	Denmark, Norway, Sweden

Appendix 3 Swedish Profiling and Reconciliation

This appendix provides a general description of the Swedish profiling and reconciliation model in eSett. This applies only for BRPs and DSOs in Sweden that have BRP level profiled consumption. The details regarding the model and data communication are available in the Svensk Elmarknadshandbok and in the Edielportalen.

- Svensk Elmarknadshandbok: <https://www.elmarknadshandboken.se/>
- Edielportalen: <https://www.ediel.se/Info/edielanvisningar>

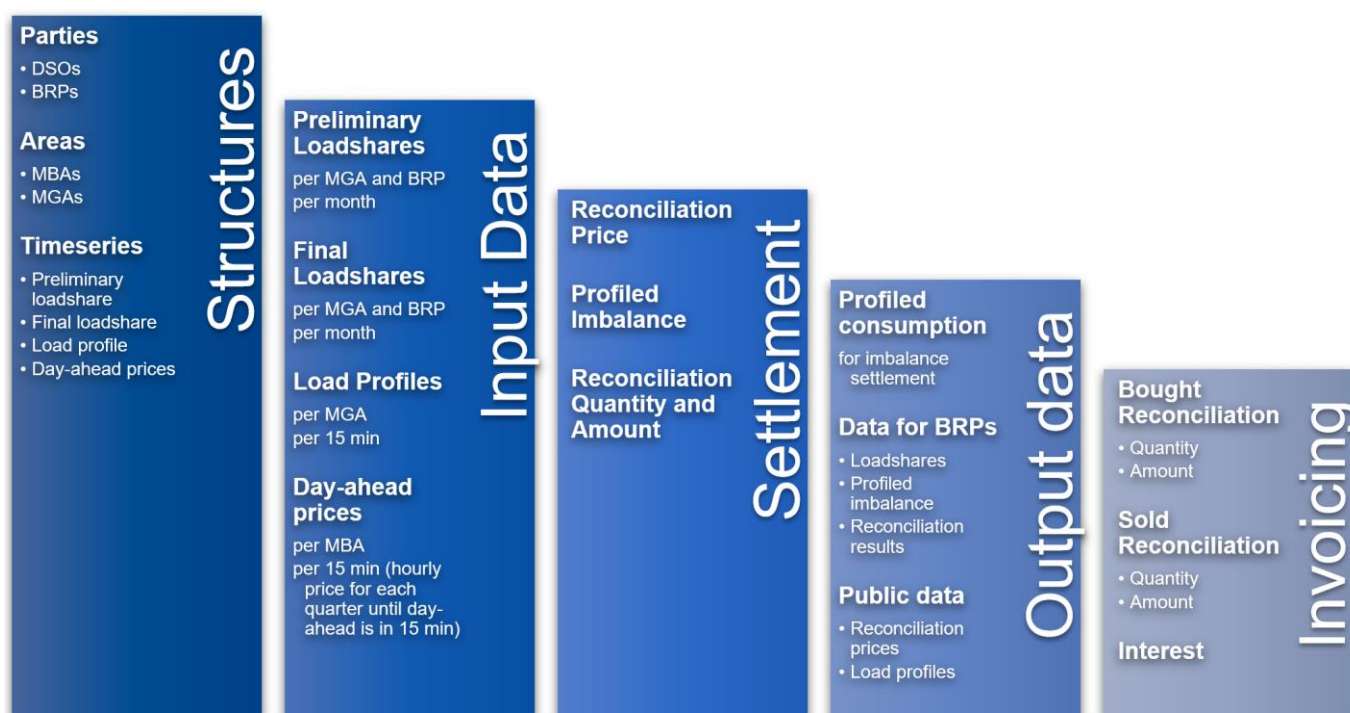

Structure Management

Swedish DSOs are responsible for keeping the BRP level profiled consumption MECs up to date on their MGAs. This includes creation and termination of necessary MECs before each delivery month. The management happens in a same way as managing RE level metered consumption.

For each MGA in Sweden, where there exists BRP level profiled consumption MEC, a load profile timeseries is automatically created. Also, for each BRP level profiled consumption MEC, a respective preliminary and final load profile share MEC is created or terminated automatically. Profiled imbalance is assigned automatically for the BRP for losses in the MGA.

Profiling and Reconciliation Time Schedule

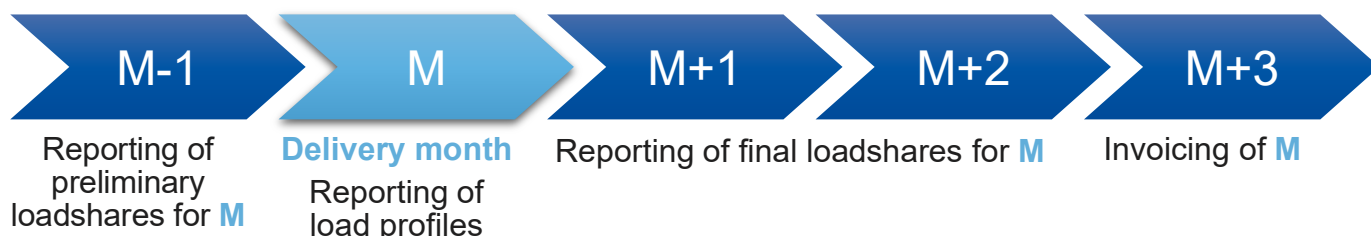

Profiling – before and during the open imbalance settlement period

Load Profile Shares are calculated by the DSO before the delivery month. eSett calculates BRPs profiled consumption per MGA. Reporting and calculation as described below:

- DSO reports Load profile shares per MGA and BRP to eSett and BRP
 - Reporting latest two days before the delivery month
 - Reported with UTILTS message type S03
 - One load profile share for losses included
- DSO reports Load profile per MGA to eSett
 - Reporting metered data before 10:00 CE(S)T the second day after delivery day
 - Reporting updated metered data before 24:00 SNT the 12th day after delivery day
 - Reported with UTILTS message type E31
- eSett calculates profiled consumption per BRP and MGA to eSett
 - Automatic calculation based on received input data for preliminary loadshares and load profiles
 - Calculated values appear into the BRP level profiled consumption MECs
- eSett reports aggregated profiled consumption per BRP and MBA to BRP
 - Results may be viewed from Online Service, or BRP may subscribe for the data packages from the Online Service, for example:
 - Profiled Consumption per MBA per BRP (15 min) – UTILTS S01
 - Profiled Consumption per MGA per BRP (15 min) – UTILTS S01
 - Profiled Consumption per MGA per BRP (month) – UTILTS S01
 - Consumption per type per BRP and MBA (15 min) – Generic DP

Reconciliation – after the imbalance settlement is finalized

The DSO reports Final Load Profile Shares to eSett. eSett calculates BRPs reconciled energy and reports it to BRPs. Reporting and calculation as described below:

- DSO reports final Load Profile Shares per MGA and BRP to eSett
 - Strong recommendation for reporting initial metered data latest on the 15th of the second month after the delivery month
 - Reporting updated metered data before the end of the second month after the delivery month
 - Reported with UTILTS message type E31
 - One load profile share for losses included
- eSett calculates the reconciled energy per BRP per MGA and aggregates it to per MBA
 - Automatic calculation based on the preliminary profiled consumption, and received load profiles and final loadshare data
- eSett reports QA data per MGA on reconciled energy to BRP
 - Results may be viewed from Online Service, or BRP may subscribe for the data packages from the Online Service:
 - Profiled Imbalance per MGA – UTILTS S01
- eSett report reconciled energy and payment per MGA and BRP
 - Results may be viewed from Online Service, or BRP may subscribe for the data packages from the Online Service:

- Reconciliation Quantity and Amount per MGA per BRP – UTILTS S01
- eSett report reconciled energy and payment per MBA/Country to BRP
 - Results may be viewed from Online Service, or BRP may subscribe for the data packages from the Online Service:
 - Reconciliation Quantity and Amount per Country per BRP – UTILTS S01
- eSett sends out invoice to BRP

Reconciliation Invoicing

Invoices are sent for the BRPs that are involved in the reconciliation in Sweden. eSett uses same customer numbers and similar logic as for the imbalance settlement invoicing. Invoicing is carried out monthly in SNT time zone.

The invoicing takes place on the first Tuesday on the third month after the delivery month. Invoices are published in the Online Service on Tuesdays by 13 CE(S)T. eSett uses direct debiting and crediting with the existing settlement accounts. More information about the invoice contents, distribution, banking setup, etc. can be found from chapter 8 Invoicing. An invoicing schedule example is presented in the figure below.

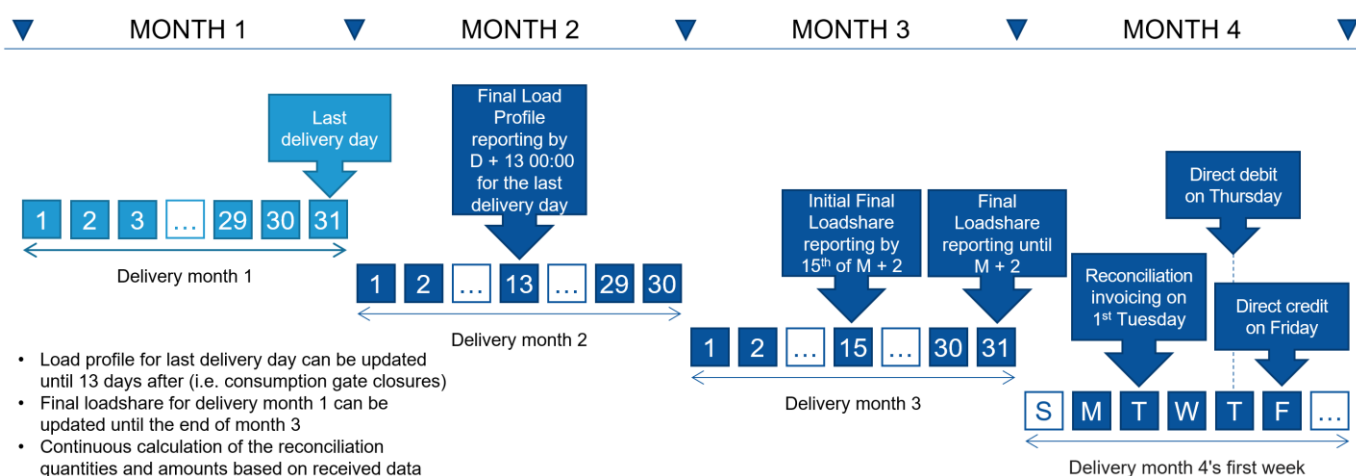

If there are one or more holidays on Monday before the invoicing or during the invoicing cycle (Tuesday to Friday), the invoicing activities on and after the holiday will be moved forward correspondingly. So, the reconciliation invoicing won't occur at the same day as imbalance settlement invoicing, and there is always the same number of business days between the events: one business day between the invoicing day and the day when incoming amounts are debited and two business days between the invoicing day and the day when outgoing amounts are paid. A holiday in any of the NBS countries will be treated as a holiday for the whole system in this regard.

An interest applies for the invoices, and Svenska kraftnät provides the interest rate to eSett. Interest may change only twice per year on 1 January or 1 July. Interest is calculated for the days from the last imbalance settlement invoicing of the month until the reconciliation invoicing of the month. E.g. interest for November 2023 is calculated for bank days from 18 December until 6 February 2024.

CONTACT INFORMATION

eSett CEO

Minnakaisa Ahonen
Phone: (+358) 10 501 8502
minnakaisa.ahonen@esett.com

eSett

Jonni Laine
Phone: (+358) 10 501 8505
jonni.laine@esett.com

Fingrid

Jani Piipponen
Phone: (+358) 30 395 4186
jani.piipponen@fingrid.fi

Svenska kraftnät

Robert Thelander
Phone: (+46) 701 41 34 05
robert.thelander@svk.se

Statnett

Kristian Bernseter
Phone: (+47) 9 171 1627
kristian.bernseter@statnett.no

Energinet

Karsten Feddersen
Phone: (+45) 23 32 31 26
KAF@energinet.dk

ESETT OY

Läkkisepäntie 23
00620 HELSINKI
Finland
Phone: (+358) 10 501 8500
settlement@esett.com

FINGRID OYJ

Läkkisepäntie 21
P.O. Box 580
00101 HELSINKI
Finland
Phone: (+358) 30 395 5000

STATNETT SF

Husebybakken 28 B
P.O. Box 5192 Majorstuen
0302 OSLO
Norway
Phone: (+47) 23 90 30 00

SVENSKA KRAFTNÅT AB

Sturegatan 1
Box 1200
172 24 Sundbyberg
Sweden
Phone: (+46) 10 475 80 00

ENERGINET

Tonne Kjærvej 65
7000 FREDERICIA
Denmark
Phone: (+45) 70 10 22 44